

Digital Policy Office

**XML SCHEMA DESIGN AND MANAGEMENT GUIDE
PART IV: APPENDICES**

[G55-4]

Version 1.5

Jul 2024

The Government of the Hong Kong Special Administrative Region
of the People's Republic of China

1
2
3
4
5
6
7
8
9
10
11
12
13
14
15
16
17
18
19
20

Distribution of Controlled Copy	
Copy No.	Holder
1	Government-wide Intranet (itginfo.ccgo.hksarg)
2	Internet (www.digitalpolicy.gov.hk)

Prepared By: XML Coordination Group

Doc. Effective Date: 1 January 2006

1

Amendment History				
Change Number	Revision Description	Sections Affected	Revision Number	Date
	Updates to consultation draft issued in July 2003		1.0	24-Nov-03
1	Emphasized that the modelling spreadsheet should be used instead of worksheets to ease capturing modelling information.	1.1.2, 1.6		
2	Added in the case study two Externally Defined Entities to capture the digital signature of the applicant and issuer in the import licence and export licence documents.	1.3, 1.7.1, 1.7.2.1, 1.7.2.2, 1.7.3		
3	Added sample user documentation to illustrate its use to help business users to verify the business requirements captured in the business information model.	1.5.1		
	Major updates to version 1.0 issued in November 2003		1.1	01-Jul-04
4	Renamed organization name from ITSD to OGCIO	Whole document		
	Major updates to version 1.1 issued in July 2004		1.2	2-Nov-04
5	Modified Figure I to advise project teams to adopt industry standard for individual data element before considering to adopt Common Schemas.	1.1.2		
6	Revised to document the enhancement of Business Information Modeling utility to allow making choice for data elements in XML Schema.	Appendix 1, Appendix 4		
	Major updates to version 1.2 issued in November 2004		1.3	4-Jan-06
7	Minor version number upgraded to 1.3 according to annual review requirement of S&M [G57].	Whole document		
8	Minor revision in light of OGCIO Circular No. 2/2015 regarding “Structured Systems Analysis and Design Methodology (SSADM)” and “Rapid Application Development (RAD)”.		1.4	30-Mar-15
9	Renamed organization name from OGCIO to DPO	Whole document		
	Major updates to version 1.4 issued in March 2015		1.5	25-Jul-24

2

3

1

2 **Table of Contents**

3 **Appendix 1 Case Study – Application for Import and Export Licences for Pharmaceutical Products**

4 **and Medicines 5**

5 1.1 BACKGROUND.....5

6 1.2 MODEL BUSINESS PROCESS11

7 1.3 DESIGN PRELIMINARY DOCUMENT STRUCTURE.....20

8 1.4 REUSE COMMON SCHEMAS25

9 1.5 DEFINE INFORMATION MODELS26

10 1.6 XML SCHEMA DEFINITION DEVELOPMENT.....29

11 1.7 ORGANIZE INFORMATION MODELS AND XML SCHEMA DEFINITIONS IN THE PROJECT REGISTRY.....30

12 1.8 POTENTIALLY REUSABLE DATA ELEMENTS51

13 **Appendix 2 Recommended List of Core Component Types.....60**

14 2.1 CORE COMPONENT TYPES AND CORRESPONDING SUPPLEMENTARY COMPONENTS.....60

15 2.2 PERMISSIBLE REPRESENTATION TERMS OF CORE COMPONENT TYPES62

16 2.3 FORMAT RESTRICTIONS FOR DIFFERENT PRIMITIVE DATA TYPES OF CONTENT COMPONENTS.....62

17 **Appendix 3 Core Component Type Worksheet64**

18 **Appendix 4 Sample XML Schema Design Worksheets.....87**

19 **Appendix 5 Implementing eBusiness Solutions96**

20 5.1 INTRODUCTION96

21 5.2 DOCUMENT FLOW96

22 5.3 MESSAGING97

23 5.4 CONCLUSION.....100

24 **Appendix 6 Intellectual Property Rights of Registry Artefacts102**

25 **Appendix 7 Glossary.....105**

26

Appendix 1 Case Study – Application for Import and Export Licences for Pharmaceutical Products and Medicines

1.1 Background

1.1.1. Objectives of This Case Study

This case study aims to demonstrate how to apply the methodology proposed in the XML Schema Design Guide to design Project Schemas. The Project Schemas are designed for three business documents exchanged in the current process for application of import and export licences for pharmaceutical products and medicines in Hong Kong.

This case is intended primarily for illustrating the use of the XML Schema Design Guide rather than for a real software solution. The Project Schemas together with the process and information models produced in this case study may need to be revised for future implementation of the software solution because of the following reasons:

1. A real software solution may involve business process reengineering, which could streamline the current manual process through software automation. Rather, the schema in this case study is developed largely based on the current manual process.
2. When this case study is developed, the Common Schemas are not in place yet. The information models and Schemas for some Business Information Entities may need to be replaced by suitable Common Schemas when they are in place. (For illustrating the use of Common Schemas in a project, it is assumed that the Common Schemas for “Hong Kong Physical Address” are found suitable for reuse in this case study. However, since these schemas are only prototyping Common Schemas and are not the version to be finalized and approved, they are expected to have considerable difference from the final version.)

1.1.2. Design Process

The XML Schema design process described in Section 2 of the Design Guide is followed to develop this case study. The flowchart shown in Figure I summarizes this design process. Subsequent sections in this Appendix are organized based on the design process flow as described below:

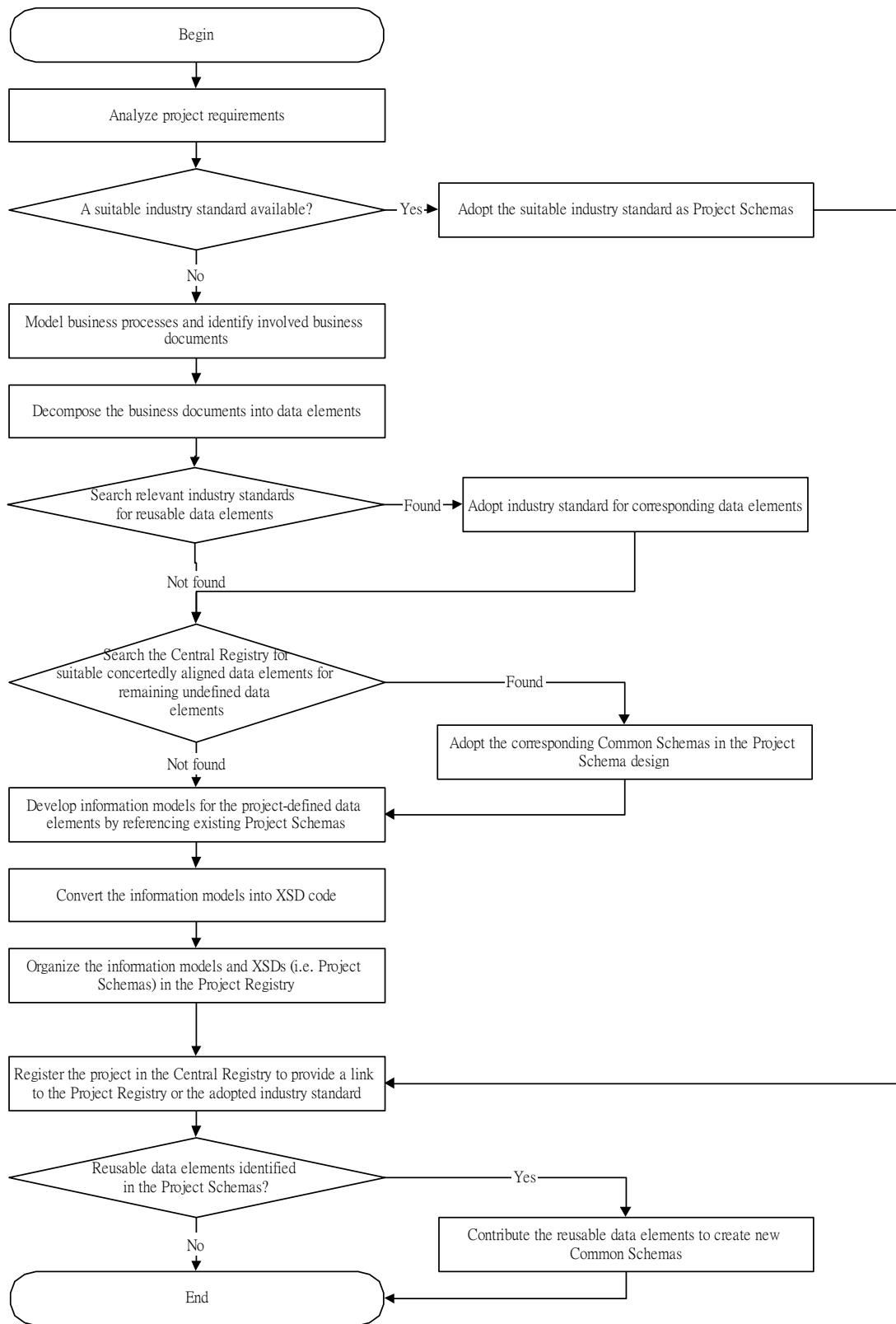

1
2
3
4

Figure I: Project Schema Design Process

- 1 1. **Analyze project requirements.** Section 1.1.3 gives a case description as the summary of the
2 requirement analysis. The physical documents of the Import Licence Form 3 (TRA 187) and
3 the Export Licence Form 6 (TRA 394) are also shown.
- 4 2. **A suitable industry standard available?** For illustration purpose, it is assumed that no
5 suitable industry standard is available for this case study.
- 6 3. **Model business processes and identify involved business documents.** Section 1.2 applies
7 the business process modelling (BPM) methodology (see Section 3 of the Design Guide) to
8 analyze and model the business processes and identify the business documents for exchange in
9 this case.
- 10 4. **Decompose the business documents into data elements.** Section 1.3 illustrates how the
11 physical documents of Import Licence Form 3 and Export Licence Form 6 can be decomposed
12 into hierarchies of data elements which forms the preliminary structures of the two documents.
- 13 5. **Search the Central Registry for suitable concerted aligned data elements.** Section 1.4
14 assumes that the prototyping Common Schemas for “HK Physical Address” are reused.
- 15 6. **Develop information models for the project-defined data elements by referencing**
16 **relevant industry standards and existing Project Schemas.** Section 1.5 illustrates how the
17 information models for the “Foreign Physical Address” are developed as an example. Sample
18 user documentations are shown in Section 1.5.1.
- 19 7. **Convert the information models to XSD code.** Section 1.6 illustrates how the information
20 models for the Foreign Physical Address are converted to XSD code as an example.
- 21 8. **Organize the information models and XSDs (i.e. Project Schemas) in the Project Registry.**
22 Section 1.7 shows the possible content in the Project Registry. It tabulates all information
23 models in the spreadsheet format, and shows the schematic and code of the XSDs converted
24 from the models.
- 25 9. **Register the project in the Central Registry to provide a link to the Project Registry or**
26 **the adopted industry standard.** If this case is a real project, the project team should register
27 it in the Central Registry.
- 28 10. **Reusable data elements identified in the Project Schemas?** It is assumed that the data
29 elements for “Foreign Physical Address” are considered to be potentially reusable in other
30 projects. The modelling worksheets (see Section 6 of the Design Guide) for these elements are
31 completed for contribution to create Common Schemas. Alternatively, the project team can
32 describe the reusable data elements using a data modelling spreadsheet.

33 1.1.3. *Case Description*

34 Under the Import and Export Ordinance (the I & E Ordinance), Chapter 60 of the Laws of Hong Kong,
35 all imports and exports of pharmaceutical products and medicines must be covered by import and
36 export licence issued by the **Director-General of Trade and Industry** represented by the Trade and
37 Industry Department.

38 Before the Trade and Industry Department (TID) processes a licence application covering imports or
39 exports of pharmaceutical products and medicines, the application must first be endorsed by the
40 **Pharmacy and Poisons Board** under the Department of Health (DH) of the Hong Kong SAR



1 Government. An organization or individual who intends to import or export pharmaceutical products
2 and medicines must file a licence application to DH.

3 The Pharmacy and Poisons Board processes approximately 7,000 Pharmaceutical Products and
4 Medicines Import and Export Licence applications from 2,000 applicants annually.

5 Filing the applications is free of charge. However, applicants, usually pharmaceutical companies, need
6 to purchase application forms from TID or Government Publications Centre.

7 Two relevant licence application forms are **Import Licence Form 3 (TRA 187)** (Figure II) and
8 **Export Licence Form 6 (TRA 394)** (Figure III). To seek the Pharmacy and Poisons Board's
9 endorsement, the applicant submits completed import licence application form (in quadruplicate) or
10 the export licence application form (in triplicate) **in person** to the Pharmaceuticals Registration and
11 Import/Export Control Section of DH.

12 A numbered receipt is issued to the applicant. For those products approved by the Pharmacy and
13 Poisons Board for importation or exportation, the applications are endorsed and passed to TID for
14 further processing. After TID returns the processed application to DH, the applicant can pick it up in
15 person at the Pharmaceuticals Registration and Import/Export Control Section with the receipt. The
16 entire process usually takes about two business days and requires the applicant to visit the Control
17 Section twice.



IMPORT LICENCE Form 3		ORIGINAL		Annex II/附件 II
Foreign Exporter (Name and Address) XYZ Co Ltd 123 First Street Washington D.C. 12345 U.S.A. (Note 3)				Date of Issue Licence No.
Importer (Name and Address) ABC Co Ltd Room 10, ABC Bldg 3000 Nathan Road Kowloon (Note 1)				THE GOVERNMENT OF THE HONG KONG SPECIAL ADMINISTRATIVE REGION Import and Export Ordinance, Cap. 60 Reserved Commodities Ordinance, Cap. 296 and any other Enactment
Business Reg. No. 12345678 (Note 2) Tel. No. 2765 4321		Conditions of issue of this licence include the following— (i) Normally this form is to be submitted in triplicate. However, for certain categories of goods, which are notified through Trade and Industry Department circulars, quadruplicates are required. (ii) The original of this licence shall be the only valid copy against which the goods described herein may be released by the carriers to the importer on arrival in Hong Kong unless special authority to permit release against a certified true copy is granted by the Director-General of Trade and Industry or an officer authorised by him. (iii) This licence must be correctly endorsed by the importer with shipment arrival details (see reverse) and the importer must not take delivery of the goods until the licence has been so endorsed; the original of the licence duly endorsed must then be passed to the shipping, airline or transportation company who should check details given by the importer and return the licence to the Trade and Industry Department together with the relevant manifest. (iv) The importer must lodge import declarations in respect of items on this licence within 14 days of shipment. (v) This licence is valid for six months from the date of issue. Extension of validity may be granted on application.		
23 August 2001 (Note 4)				
By Air, Flight No. CX 100 (Note 5)				
WARNING : All alterations must be carried out by authorized officers. Heavy penalties are provided for false declaration and information, unauthorized alterations and misuse of this licence.				
Marks and Nos.; Container No.; ABC Order No. C/No. 1-50 (Note 6)	No. and Kind of Packages; Brand and Model; Fifty (50) cartons 1. Tetracycline HCL BP80 2. Nutroplex Liquid 120 ml per bottle 3. Aminophylline Injection 2.5% 10 ml vial; 10 vials per box	DESCRIPTION OF GOODS (Note 7) (Note 8)	No. of Units (Note 9) *2,500* kg *24* bottles *2,000* boxes	*C.I.F. Value HKD 48,000.00 12,000.00 25,000.00
		(Note 10)		
* C.I.F. Value HK comprises the cost of the goods to the HK importer up to the arrival in HK of the vessel, vehicle or aircraft carrying the goods, together with the amount of the insurance, freight and any other charges. HKD means Hong Kong Dollar.			Total	85,000.00
		Exporting Country USA	IMPORTER'S DECLARATION I hereby declare that I am the importer of the goods in respect of which this declaration is made and that the particulars given in this declaration are true and that the goods imported shall be as described. I further declare that the goods are for (a) local consumption (b) re-export to CHINA (Note 11)	
Item No. 1 2 3 4 5	Origin Country Canada USA Puerto Rico (Note 15)	* (Delete (a) or (b) where not applicable) Signatory's Name in Block Letters CHAN MAN (Note 12)		
		Approved for Director-General of Trade and Industry	Date, Signature & Company Chop Chan (Note 13) 23 July 2001 (Note 14) 	

1
2

TRA 187 (Rev. 2001)

IMPORTANT – SEE REVERSE

Figure II: Import Licence Form 3 (TRA 187).

EXPORT LICENCE Form 6		ORIGINAL		Annex III 附件 III	
Exporter (Name and Address) ABC Co Ltd Room 10, ABC Bldg (Note 1) 3000 Nathan Road, Kowloon Business Reg. No. 12345678 (Note 2) Tel. No. 2765 4321		 THE GOVERNMENT OF THE HONG KONG SPECIAL ADMINISTRATIVE REGION Import and Export Ordinance, Cap. 60 Reserved Commodities Ordinance, Cap. 296 and any other Enactment		Date of Issue _____ Licence No. _____	
Consignee (Name and Address) XXX Co Ltd 99 Guanghua Road (Note 3) Beijing China				Conditions of issue of this licence include the following:— (i) Normally this form is to be submitted in duplicate. However for certain categories of goods, which are notified through Trade and Industry Department circulars, triplicates are required. (ii) Any number of items in licensable categories may be entered on this form provided all are shipped at the same time on the same vessel, aircraft or vehicle. (iii) The original must be given to the shipping, airline or transportation company for return to the Trade and Industry Department together with the relevant manifest. (iv) The exporter must lodge export declarations in respect of items on this licence within 14 days of shipment. (v) The name and address of the Hong Kong manufacturer or processor must be provided for locally produced commodities covered by this licence. (vi) In the case of re-exports, condition (v) does not apply. However, the country of origin of the items must be shown in the box provided for the purpose on this licence. (vii) This licence is valid for twenty eight days from the date of issue.	
Departure Date 1 August 2001 (Note 4)					
Vessel/Flight/Vehicle No. By Sea (Note 5)					
WARNING: All alterations must be carried out by authorized officers. Heavy penalties are provided for false declaration & information, unauthorized alterations & misuse of this licence.					
Marks and Nos., Container No., XXX Order No. C/No. 1-150 (Note 6)		No. and Kind of Packages, Brand & Model One hundred and fifty (150) cartons (Note 7)		DESCRIPTION OF GOODS (Note 8)	
		1. "Flower" Brand Red Flower Medicated Oil 60 ml per bottle 2. Hemagram capsule 10 mg 60 capsules per bottle		No. of Units (Note 9) *3,000* dozen *1,000* bottles	
				F.O.B. Value HKD 93,000.00 65,000.00	
				Total 158,000.00	
		Destn. Country & Code China 631 (Note 16)		EXPORTER'S DECLARATION I hereby declare that I am the exporter of the goods in respect of which this declaration is made and that the particulars given in this declaration are true and that the value declared above is the full value.	
Origin Country 1 Hong Kong 2 USA 3 (Note 15)		Origin Country Code 690 111 (Note 16)		Name and Address of HK Manufacturer/ Processor 1. Flower Brand Oil Factory 12/E, 300 Castle Peak Road Lai Chi Kok Kowloon (Note 17)	
4 5		Approved for Director-General of Trade and Industry		Signature and Date Chan 23 July 2001 (Note 13) Signatory's Name in Block Letters CHAN MAN (Note 12) Company Chop (Note 14) 	

TRA 394 (Rev. 2000)

Figure III: Export Licence Form 6 (TRA 394).

1.2 Model Business Process

This section illustrates how the business process modelling (BPM) methodology (Section 3 of the Design Guide) is applied to analyze and model the business process systematically, and to identify the business documents necessary for the next step of the XML Schema design process – business information modelling.

To model this business process, the business analyst of the project first prepares an activity diagram for the business collaboration (Figure IV and Part F of the Business Collaboration Worksheet).

Rectangles in the diagram denote messages being exchanged by the collaborating parties.

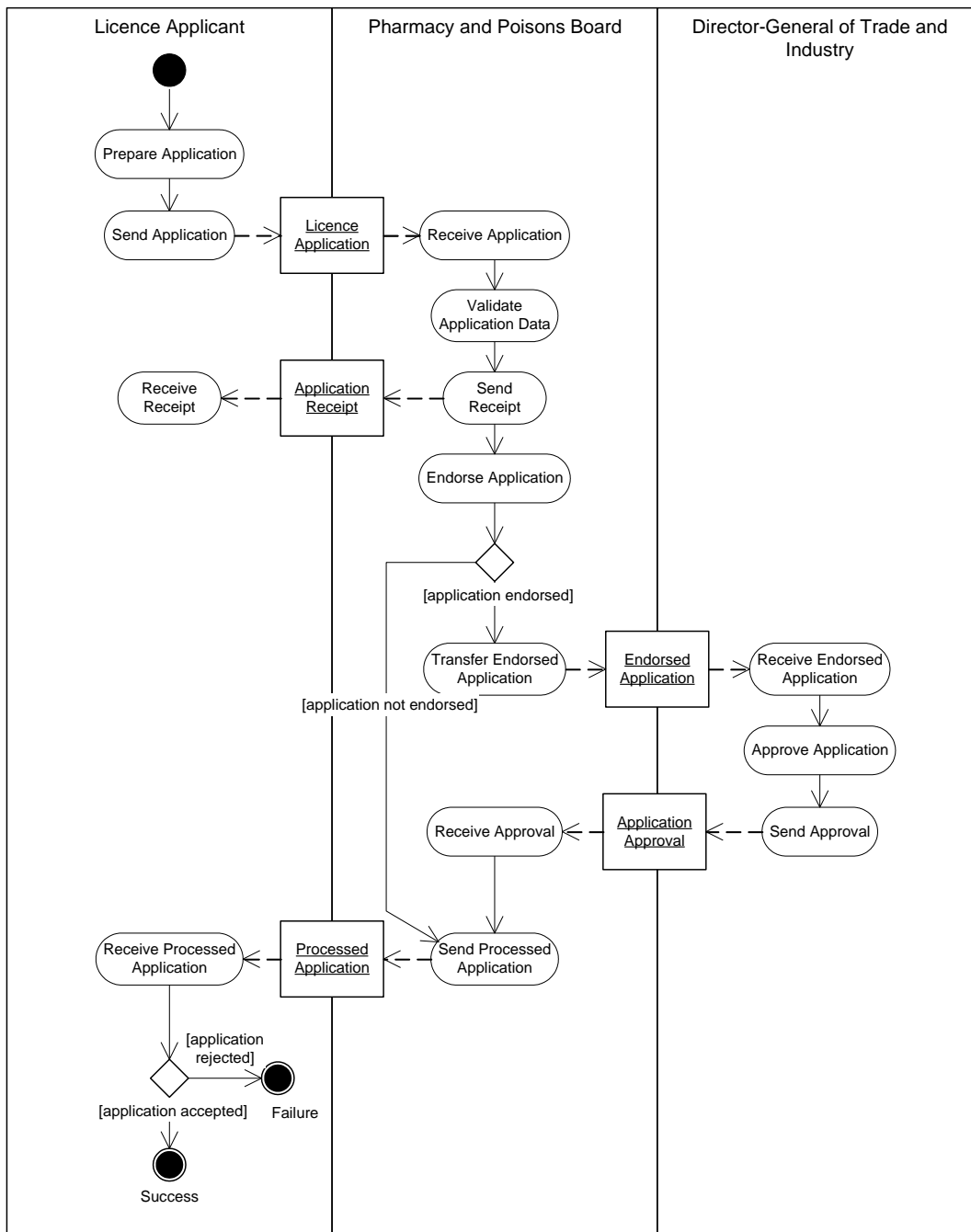

Figure IV Business Process of Application for Import and Export Licences for Pharmaceutical Products and Medicines

1 From the Activity Diagram, the business analyst can identify the business transactions involved in the
2 collaboration (see Part F of the Business Collaboration Worksheet). A business transaction is an
3 atomic unit of work carried out by two business partners, and is an abstraction of one exchange of
4 documents. In this case, three business transactions have been identified: **Submit Licence Application**,
5 **Approve Licence Application**, and **Return Processed Application** (shown as three dotted-rectangles
6 in Part F of the Business Collaboration Worksheet). For each of these business transactions, the
7 business analyst fills in a Business Transaction Worksheet. Further analysis on these business
8 transactions concludes that three business documents, **Import Licence**, **Export Licence**, and
9 **Acknowledgement** are being exchanged. These documents are packaged into five messages
10 (rectangles in the activity diagram) in the above transactions. Finally, the business analyst fills in a
11 Business Collaboration Worksheet to consolidate all the business transaction and business documents
12 identified in the collaboration. The worksheets are shown in the following pages.

13

Table I: Business Transaction for “Submit Licence Application”

BUSINESS TRANSACTION WORKSHEET

A. Worksheet Information	
Worksheet ID: BTWS-SUBMIT-LICENCE-APPLICATION	Project ID: XMLGL
Technical Contact: Josia Chan / CECID	Administrative Contact: Thomas Lee / CECID

B. Business Transaction Properties	
Name: Submit Licence Application	One/Two-Way: Two-way
Description: An individual or organization submits an application for an import or export licence for pharmaceutical products and medicines.	
Scope: 1. An individual or organization (applicant) sends an application for an import or export licence for pharmaceutical products and medicines to the Pharmacy and Poisons Board for processing. 2. The Pharmacy and Poisons Board replies to the applicant with an application receipt.	
Pre-conditions: The applicant requests a licence to import or export pharmaceutical products and medicines.	
Requesting Role: Licence Applicant	Responding Role: Pharmacy and Poisons Board

C. Request Document Flow		
Description: The applicant sends an import or export licence application to the Pharmacy and Poisons Board for processing.		
Non-Repudiation Required: Yes	Data Confidentiality Required: Yes	
C1. Request Documents		
<i>No.</i>	<i>Document Name</i>	<i>Business Information Carried</i>
1	Import Licence Form	When an import licence is applied for: the application data for an import licence for pharmaceutical products and medicines
2	Export Licence Form	When an export licence is applied for: the application data for an export licence for pharmaceutical products and medicines

D. Response Document Flow		
Description: The Pharmacy and Poisons Board replies to the applicant with an application receipt.		
Success Conditions: The application data is valid.		
Non-Repudiation Required: Yes	Data Confidentiality Required: Yes	
D1. Positive Response Documents		
<i>No.</i>	<i>Document Name</i>	<i>Business Information Carried</i>
1	Acknowledgement	The application receipt indicating that the application has been accepted for processing.
2	Import Licence	When an import licence is applied for: the original import licence application
3	Export Licence	When an export licence is applied for: the original export licence application
D2. Negative Response Documents		
<i>No.</i>	<i>Document Name</i>	<i>Business Information Carried</i>
1	Acknowledgement	The application receipt indicating that the

		application has been rejected because some application data is invalid.
2	Import Licence	When an import licence is applied for: the original import licence application
3	Export Licence	When an export licence is applied for: the original export licence application

1
2
3

Table II: Business Transaction for “Approve Licence Application”

BUSINESS TRANSACTION WORKSHEET

A. Worksheet Information	
Worksheet ID: BTWS-APPROVE-LICENCE-APPLICATION	Project ID: XMLGL
Technical Contact: Josia Chan / CECID	Administrative Contact: Thomas Lee / CECID

B. Business Transaction Properties	
Name: Approve Licence Application	One/Two-Way: Two-way
Description: The Pharmacy and Poisons Board transfers an endorsed licence application for approval by the Director-General of Trade and Industry.	
Scope: 1. The Pharmacy and Poisons Board sends an endorsed application to the Director-General of Trade and Industry for approval. 2. The Director-General of Trade and Industry approves (or disapproves) the application and replies to the Pharmacy and Poisons Board with an application approval (or disapproval).	
Pre-conditions: The Pharmacy and Poisons Board has endorsed the pharmaceutical products and medicines in the licence application.	
Requesting Role: Pharmacy and Poisons Board	Responding Role: The Director-General of Trade and Industry (DG of T&I)

C. Request Document Flow		
Description: The Pharmacy and Poisons Board sends an endorsed application to the Director-General of Trade and Industry for approval.		
Non-Repudiation Required: Yes		Data Confidentiality Required: Yes
C1. Request Documents		
<i>No.</i>	<i>Document Name</i>	<i>Business Information Carried</i>
1	Import Licence	When an import licence is applied for: the application data for an import licence for pharmaceutical products and medicines
2	Export Licence	When an export licence is applied for: the application data for an export licence for pharmaceutical products and medicines

D. Response Document Flow		
Description: The Director-General of Trade and Industry replies to the Pharmacy and Poisons Board with an application approval.		
Success Conditions: The licence application is approved by the Director-General of Trade and Industry.		
Non-Repudiation Required: Yes		Data Confidentiality Required: Yes
D1. Positive Response Documents		
<i>No.</i>	<i>Document Name</i>	<i>Business Information Carried</i>
1	Acknowledgement	An indication that the licence application has been approved
2	Import Licence	When an import licence is applied for: the import licence issued by the DG of T&I
3	Export Licence	When an export licence is applied for: the export licence issued by the DG of T&I

D2. Negative Response Documents		
<i>No.</i>	<i>Document Name</i>	<i>Business Information Carried</i>
1	Acknowledgement	An indication that the licence application has been rejected
2	Import Licence Form	When an import licence is applied for: The original import licence application
3	Export Licence Form	When an import licence is applied for: The original export licence application

1
2
3

Table III: Business Transaction for “Return Processed Application”

BUSINESS TRANSACTION WORKSHEET

A. Worksheet Information	
Worksheet ID: BTWS-RETURN-PROCESSED-APPLICATION	Project ID: XMLGL
Technical Contact: Josia Chan / CECID	Administrative Contact: Thomas Lee / CECID

B. Business Transaction Properties	
Name: Return Processed Application	One/Two-Way: One-way
Description: The Pharmacy and Poisons Board returns a processed application to the applicant.	
Scope: The Pharmacy and Poisons Board sends a processed application to the applicant.	
Pre-conditions: The application has been processed by the Director-General of Trade and Industry, or the application is not endorsed by the Pharmacy and Poisons Board.	
Requesting Role: Pharmacy and Poisons Board	Responding Role: Licence Applicant

C. Request Document Flow		
Description: The Pharmacy and Poisons Board returns a processed application to the applicant.		
Non-Repudiation Required: Yes		Data Confidentiality Required: Yes
C1. Request Documents		
<i>No.</i>	<i>Document Name</i>	<i>Business Information Carried</i>
1	Acknowledgement	An indication whether the application is successful.
1	Import Licence	When an import licence is applied for: the import licence if the import application is successful; the original application otherwise.
2	Export Licence	When an export licence is applied for: the export licence if the export application is successful; the original application otherwise.

D. Response Document Flow		
Description:		
Success Conditions:		
Non-Repudiation Required:		Data Confidentiality Required:
D1. Positive Response Documents		
<i>No.</i>	<i>Document Name</i>	<i>Business Information Carried</i>
D2. Negative Response Documents		
<i>No.</i>	<i>Document Name</i>	<i>Business Information Carried</i>

Table IV: Business Collaboration for " Application for Import and Export Licences for Pharmaceutical Products and Medicines"

BUSINESS COLLABORATION WORKSHEET

A. Worksheet Information	
Worksheet ID: BCWS-PHARMIE	Project ID: XMLGL
Technical Contact: Josia Chan / CECID	Administrative Contact: Thomas Lee / CECID

B. Business Collaboration Properties
Name: Application for import / export licence for pharmaceutical products and medicines
Description: An individual or organization applies to the Hong Kong SAR Government for an import or export licence for pharmaceutical products and medicines.
Scope:
Pre-conditions:

C. Roles	
<i>Name</i>	<i>Description</i>
Licence Applicant	An individual or organization who applies for an import or export licence
Pharmacy and Poisons Board	The authority who endorses the pharmaceutical products and medicines for import and export
Director-General of Trade and Industry	The authority who issues import and export licences

D. Business Transactions	
<i>Name</i>	<i>Description</i>
Submit Licence Application	An individual or organization submits an application for an import or export licence for pharmaceutical products and medicines.
Approve Licence Application	The Pharmacy and Poisons Board transfers an endorsed licence application for approval by the Director-General of Trade and Industry.
Return Processed Application	The Pharmacy and Poisons Board returns a processed application to the applicant.

E. Business Documents	
<i>Name</i>	<i>Description</i>
Import Licence	The data of an import licence application or the licence issued
Export Licence	The data of an export licence application or the licence issued
Acknowledgement	The status of a licence application

1

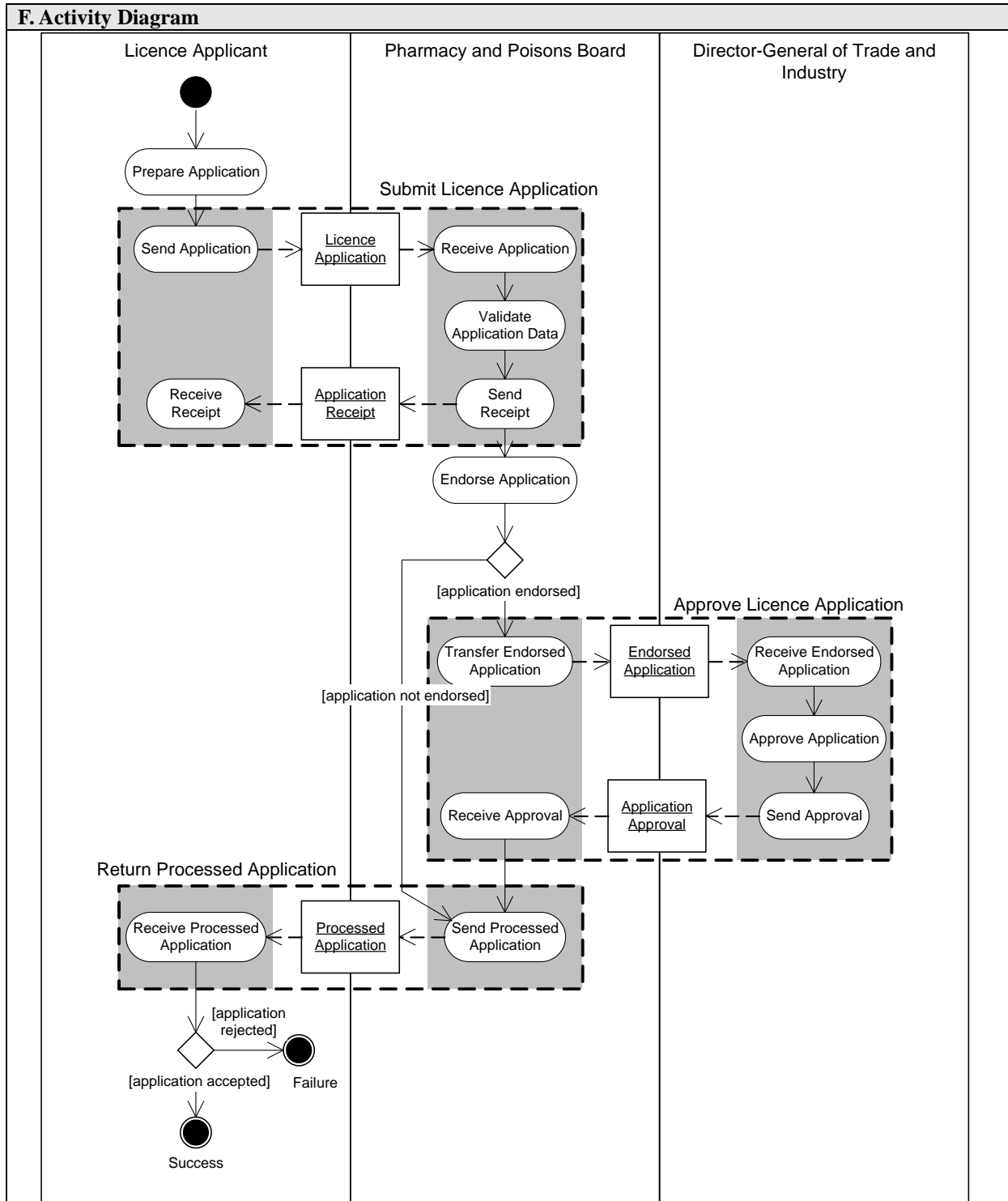

2

3

1.3 Design Preliminary Document Structure

The first step to model a business document identified in business process modelling is to decompose that document into a hierarchical structure of data elements. The layout of an existing physical document is a very useful reference for designing the preliminary document structure.

Figure V and Figure VII illustrate how the business analyst group data fields on the Import and Export Licence Forms into building blocks or components. Figure VI and Figure VIII show the UML class diagrams in which the business analyst organizes these components in hierarchical structures for the “Import Licence” and “Export Licence” documents. Note that these structures are only preliminary document structures and the business analyst should further decompose these structures into the most elementary components.

Since the “Acknowledgement” document is created to facilitate system process and does not have a physical document version, the business analyst is required to design the document structure from scratch as shown in Figure IX.

IMPORT LICENCE Form 3 **ORIGINAL**

Foreign Exporter (Name and Address) Exporter XYZ Co Ltd 123 First Street (Note 3) Washington D.C. 12345 U.S.A.	Date of Issue Licence No. <div style="text-align: center; border: 1px solid black; padding: 5px;"> THE GOVERNMENT OF THE HONG KONG SPECIAL ADMINISTRATIVE REGION Import and Export Ordinance, Cap. 60 Reserved Commodities Ordinance, Cap. 296 and any other Enactment </div>
Importer (Name and Address) Importer ABC Co Ltd Room 10, ABC Bldg (Note 1) 3000 Nathan Road Kowloon Business Reg. No. 12345678 (Note 2) Tel. No. 2765 4321	Conditions of issue of this licence include the following: <ul style="list-style-type: none"> (i) Normally this form is to be submitted in triplicate. However, for certain categories of goods, which are notified through Trade and Industry Department circulars, quadruplicates are required. (ii) The original of this licence shall be the only valid copy against which the goods described herein may be released by the carriers to the importer on arrival in Hong Kong unless special authority to permit release against a certified true copy is granted by the Director-General of Trade and Industry or an officer authorised by him. (iii) This licence must be correctly endorsed by the importer with shipment arrival details (see reverse) and the importer must not take delivery of the goods until the licence has been so endorsed; the original of the licence duly endorsed must then be passed to the shipping, airline or transportation company who should check details given by the importer and return the licence to the Trade and Industry Department together with the relevant manifest. (iv) The importer must lodge import declarations in respect of items on this licence within 14 days of shipment. (v) This licence is valid for six months from the date of issue. Extension of validity may be granted on application.
23 August 2001 Transport	
By Air, Flight No. CX 100 (Note 5)	

WARNING : All alterations must be carried out by authorized officers. Heavy penalties are provided for false declaration and information, unauthorized alterations and misuse of this licence.

Marks and Nos.; Container No.;	No. and Kind of Packages; Brand and Model;	DESCRIPTION OF GOODS	No. of Units	*C.I.F. Value HKD	Goods
ABC Order No. C/No. 1-50 (Note 6)	Fifty (50) cartons 1. Tetracycline HCL BP80 2. Nutroplex Liquid 120 ml per bottle 3. Aminophylline Injection 2.5% 10 ml vial; 10 vials per box	(Note 7) (Note 8)	(Note 9) *2,500* Kg *24* bottles *2,000* boxes	48,000.00 12,000.00 25,000.00	Item
(Note 10)					
* C.I.F. Value HK comprises the cost of the goods to the HK importer up to the arrival in HK of the vessel, vehicle or aircraft carrying the goods, together with the amount of the insurance, freight and any other charges. HKD means Hong Kong Dollar.				Total	85,000.00

Exporting Country USA Exporting Country	IMPORTER'S DECLARATION I hereby declare that I am the importer of the goods in respect of which this declaration is made and that the particulars given in this declaration are true and that the goods described are for (a) local consumption (b) re-export to CHINA (Note 11) <small>(Delete (a) or (b) where not applicable)</small>												
<table border="1" style="width: 100%; border-collapse: collapse;"> <thead> <tr> <th style="width: 10%;">Item No.</th> <th style="width: 90%;">Origin Country</th> </tr> </thead> <tbody> <tr><td>1</td><td>Canada</td></tr> <tr><td>2</td><td>USA</td></tr> <tr><td>3</td><td>Puerto Rico</td></tr> <tr><td>4</td><td>(Note 15)</td></tr> <tr><td>5</td><td></td></tr> </tbody> </table>	Item No.	Origin Country	1	Canada	2	USA	3	Puerto Rico	4	(Note 15)	5		Signatory's Name in Block Letters Application CHAN MAN (Note 12)
Item No.	Origin Country												
1	Canada												
2	USA												
3	Puerto Rico												
4	(Note 15)												
5													
Approved Licence Issuing Information for Director-General of Trade and Industry	Date, Signature & Company Chop Chan (Note 13) 23 July 2001 (Note 14)												

1
2

Figure V: Grouping data elements on the Import Licence Form.

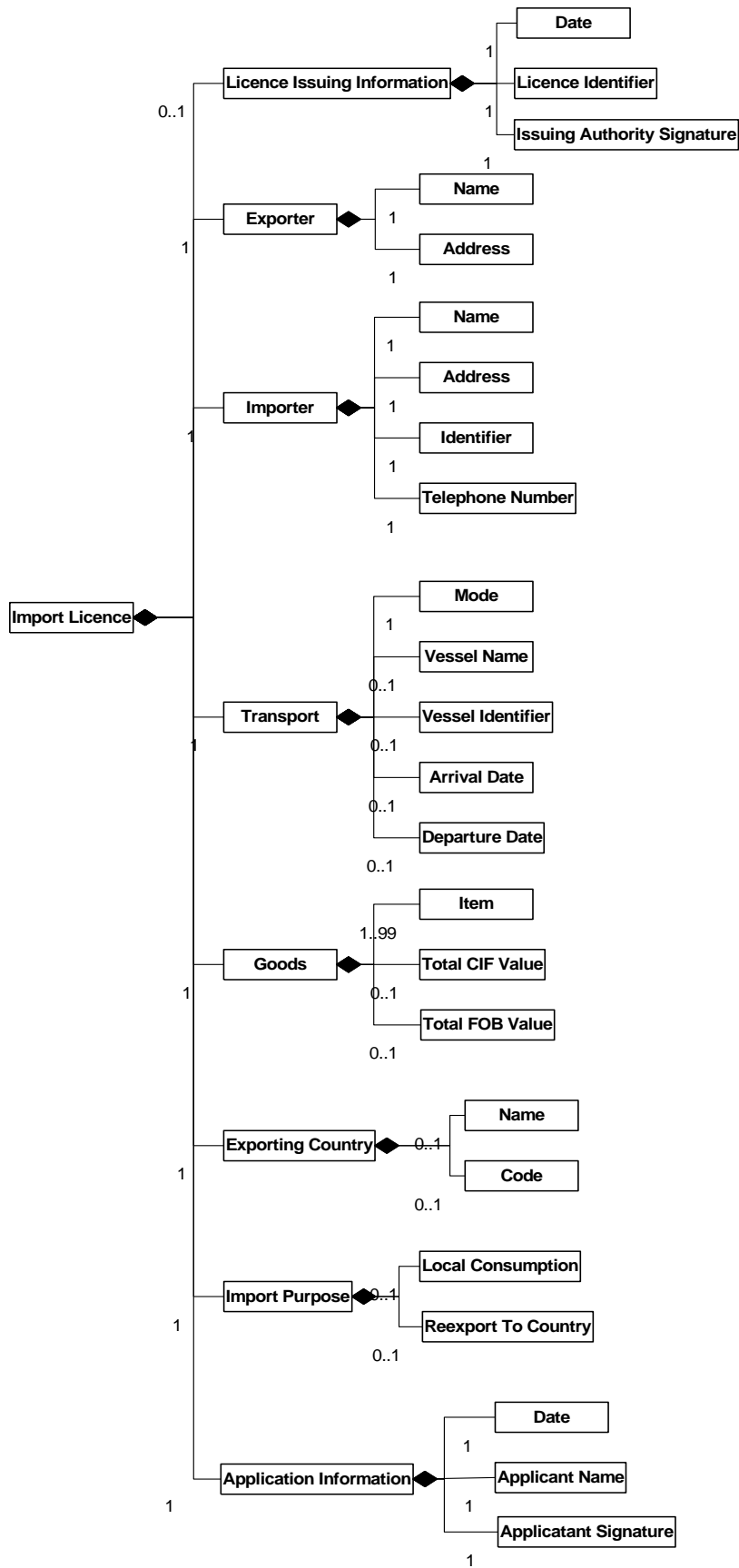

1
 2
 3

Figure VI: The preliminary structure for the "Import Licence" document.

1

EXPORT LICENCE Form 6 ORIGINAL

<p>Exporter (Name and Address) Exporter</p> <p>ABC Co Ltd Room 10, ABC Bldg (Note 1) 3000 Nathan Road, Kowloon</p> <p>Business Req. No. 12345678 (Note 2) Tel. No. 2765 4321</p> <hr/> <p>Consignee (Name and Address) Consignee</p> <p>XXX Co Ltd 99 Guanghua Road (Note 3) Beijing China</p> <hr/> <p>Departure Date Transport</p> <p>1 August 2001 (Note 4)</p> <p>Vessel/Flight/Vehicle No.</p> <p>By Sea (Note 5)</p>	<p>Date of Issue _____ Licence No. _____</p> <p style="text-align: center;">THE GOVERNMENT OF THE HONG KONG SPECIAL ADMINISTRATION Import and Export Ordinance, Cap. 60 Reserved Commodities Ordinance, Cap. 296 and any other Enactment</p> <hr/> <p>Conditions of issue of this licence include the following:—</p> <ul style="list-style-type: none"> (i) Normally this form is to be submitted in duplicate. However for certain categories of goods, which are notified through Trade and Industry Department circulars, triplicates are required. (ii) Any number of items in licensable categories may be entered on this form provided all are shipped at the same time on the same vessel, aircraft or vehicle. (iii) The original must be given to the shipping, airline or transportation company for return to the Trade and Industry Department together with the relevant manifest. (iv) The exporter must lodge export declarations in respect of items on this licence within 14 days of shipment. (v) The name and address of the Hong Kong manufacturer or processor must be provided for locally produced commodities covered by this licence. (vi) In the case of re-exports, condition (v) does not apply. However, the country of origin of the items must be shown in the box provided for the purpose on this licence. (vii) This licence is valid for twenty eight days from the date of issue. 																																				
WARNING: All alterations must be carried out by authorized officers. Heavy penalties are provided for false declaration & information, unauthorized alterations & misuse of this licence.																																					
<table border="1" style="width: 100%; border-collapse: collapse;"> <thead> <tr> <th style="width: 15%;">Marks and Nos., Container No.,</th> <th style="width: 25%;">No. and Kind of Packages, Brand & Model</th> <th style="width: 30%;">DESCRIPTION OF GOODS</th> <th style="width: 10%;">No. of Units</th> <th style="width: 10%;">F.O.B. Value HKD</th> <th style="width: 10%;"></th> </tr> </thead> <tbody> <tr> <td>XXX Order No. C/No. 1-150 (Note 6)</td> <td>One hundred and fifty (150) cartons (Note 7)</td> <td>(Note 8)</td> <td>(Note 9)</td> <td></td> <td style="text-align: center;">Item</td> </tr> <tr> <td></td> <td>1. "Flower" Brand Red Flower Medicated Oil 60 ml per bottle</td> <td>(Note 8)</td> <td>*3,000* dozen</td> <td>93,000.00</td> <td></td> </tr> <tr> <td></td> <td>2. Hemagram capsule 10 mg 60 capsules per bottle</td> <td></td> <td>*1,000* bottles</td> <td>65,000.00</td> <td></td> </tr> <tr> <td colspan="5" style="text-align: center;">(Note 10)</td> <td></td> </tr> <tr> <td colspan="4"></td> <td style="text-align: right;">Total</td> <td>158,000.00</td> </tr> </tbody> </table>		Marks and Nos., Container No.,	No. and Kind of Packages, Brand & Model	DESCRIPTION OF GOODS	No. of Units	F.O.B. Value HKD		XXX Order No. C/No. 1-150 (Note 6)	One hundred and fifty (150) cartons (Note 7)	(Note 8)	(Note 9)		Item		1. "Flower" Brand Red Flower Medicated Oil 60 ml per bottle	(Note 8)	*3,000* dozen	93,000.00			2. Hemagram capsule 10 mg 60 capsules per bottle		*1,000* bottles	65,000.00		(Note 10)										Total	158,000.00
Marks and Nos., Container No.,	No. and Kind of Packages, Brand & Model	DESCRIPTION OF GOODS	No. of Units	F.O.B. Value HKD																																	
XXX Order No. C/No. 1-150 (Note 6)	One hundred and fifty (150) cartons (Note 7)	(Note 8)	(Note 9)		Item																																
	1. "Flower" Brand Red Flower Medicated Oil 60 ml per bottle	(Note 8)	*3,000* dozen	93,000.00																																	
	2. Hemagram capsule 10 mg 60 capsules per bottle		*1,000* bottles	65,000.00																																	
(Note 10)																																					
				Total	158,000.00																																
<table border="1" style="width: 100%; border-collapse: collapse;"> <thead> <tr> <th style="width: 5%;">Item No.</th> <th style="width: 20%;">Origin Country</th> <th style="width: 10%;">Origin Country Code</th> <th style="width: 65%;">Name and Address of HK Manufacturer</th> </tr> </thead> <tbody> <tr> <td>1</td> <td>Hong Kong</td> <td>690</td> <td>1. Flower Brand Oil Factory 12/F, 300 Castle Peak Road Lai Chi Kok Kowloon (Note 17)</td> </tr> <tr> <td>2</td> <td>USA</td> <td>111</td> <td></td> </tr> <tr> <td>3</td> <td>(Note 15)</td> <td>(Note 16)</td> <td></td> </tr> <tr> <td>4</td> <td></td> <td></td> <td></td> </tr> <tr> <td>5</td> <td></td> <td></td> <td></td> </tr> </tbody> </table>	Item No.	Origin Country	Origin Country Code	Name and Address of HK Manufacturer	1	Hong Kong	690	1. Flower Brand Oil Factory 12/F, 300 Castle Peak Road Lai Chi Kok Kowloon (Note 17)	2	USA	111		3	(Note 15)	(Note 16)		4				5				<p>Destn. Country Destination Country</p> <p>China 631</p> <hr/> <p>Processor</p> <p>Approved Licence Issuing Information</p> <p>for Director-General of Trade and Industry</p>												
Item No.	Origin Country	Origin Country Code	Name and Address of HK Manufacturer																																		
1	Hong Kong	690	1. Flower Brand Oil Factory 12/F, 300 Castle Peak Road Lai Chi Kok Kowloon (Note 17)																																		
2	USA	111																																			
3	(Note 15)	(Note 16)																																			
4																																					
5																																					
<p style="text-align: center;">EXPORTER'S DECLARATION</p> <p>I hereby declare that I am the exporter of the goods in respect of which this declaration is made and that the particulars given in this declaration are true and that the value declared above is the full value.</p> <hr/> <p>Signature and Date Application</p> <p>Chan 23 July 2001</p> <p>Signatory's Name in Block Letters</p> <p>CHAN MAN (Note 12)</p> <hr/> <p>Company Chop (Note 14)</p> <p style="text-align: right;">ABC Co Ltd</p>																																					

TRA 394 (Rev. 2000)

2
3
4

Figure VII: Grouping data elements on the Export Licence Form.

1

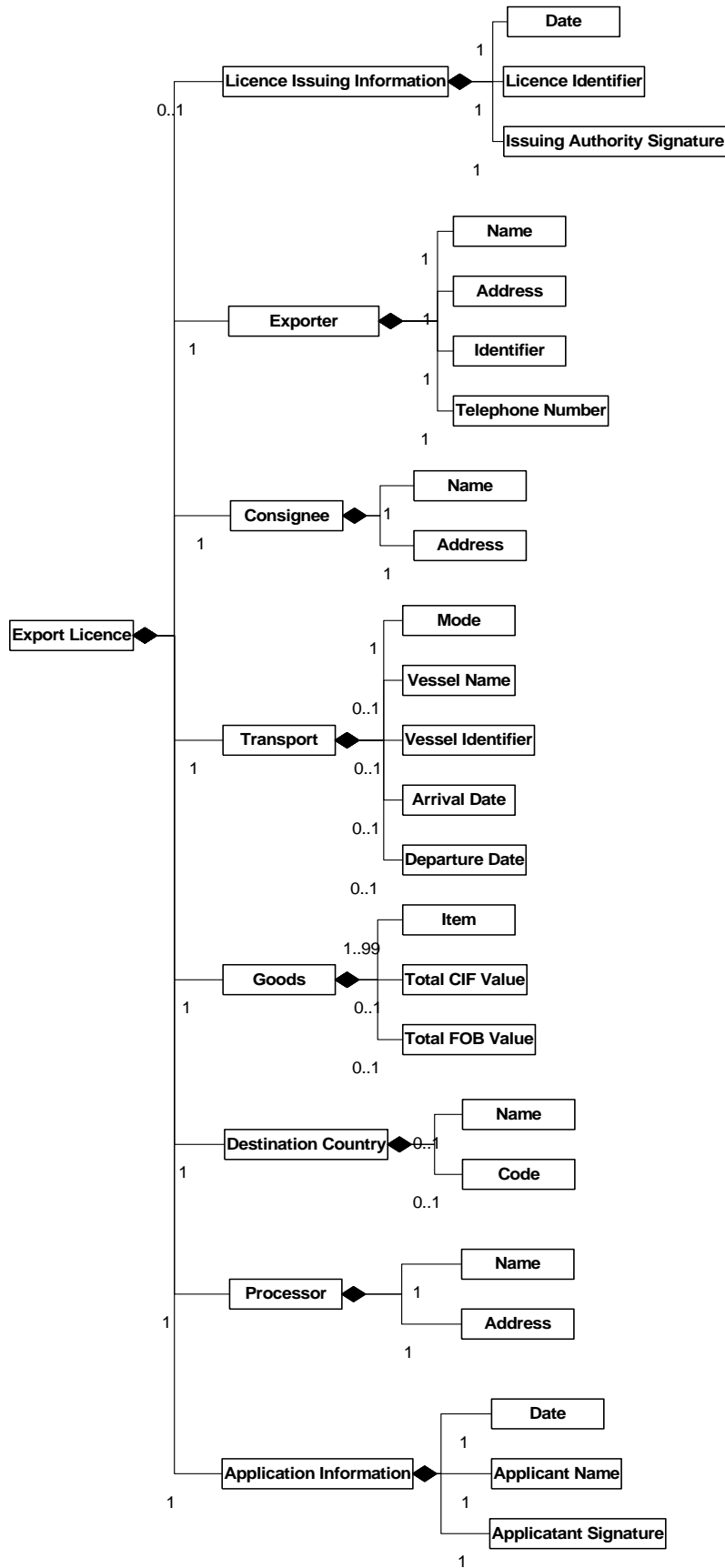

2

3

Figure VIII: The preliminary structure of the "Export Licence" document.

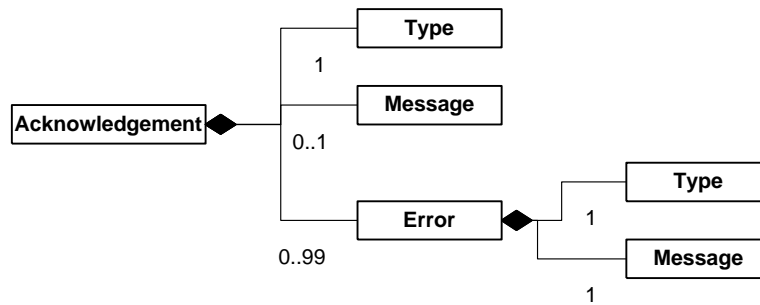

1
2 Figure IX: The document structure for the “Acknowledgement” document.

3 1.4 Reuse Common Schemas

4 According to each data component (or element) identified in the preliminary document structures as
5 obtained in the previous section, the business analyst should search the Central Registry for any
6 concerted data element suitable for reuse. If a suitable concerted data element is
7 found, the corresponding Common Schemas should be adopted in the Project Schemas.

8 Since the Common Schemas are not yet in place when this case study is developed, for illustration
9 purpose, it is assumed that the Common Schemas for “Country” and “Hong Kong Physical Address”
10 are found suitable. Table V and Table VI show part of the information models of these two Common
11 Schemas which the business analyst has copied from the Central Registry to the Project Registry. The
12 business analyst has created project-defined data elements based on these Common Schemas and has
13 marked reuse references as highlighted in the rectangles in bold.

14 Table V: Replicating the information models of the “Country” Common Schemas in the Project Schemas

Dictionary Index		Dictionary Information	Reuse of Common Schema				Object Class and Property		
Dictionary Entry Name	BIE Type	Definition	UID	Dictionary Entry Name	Object Class Term	Property Term	Object Class Term	Property Term	Cardinality
Country.Details	ABIE	Identification of a country or other geographical entity as specified in ISO 3166	COM00001	Country.Details	Country	Details	country	Details	
Country.Name	BBIE	Name of a country or other geographical entity as specified in ISO 3166	COM00002	Country.Name	Country	Name	country	Name	0-1
Country.Code	BBIE	Code identifying the name of the country or other geographical entity specified in ISO 3166	COM00003	Country.Code	Country	Code	country	Code	0-1

15
16
17

1 Table VI: Replicating the information models of the “HK Physical Address” Common Schemas in the Project
2 Schemas

Dictionary Index		Dictionary Information	Reuse of Common Schema				Object Class and Property		
Dictionary Entry Name	BIE Type	Definition	UID	Dictionary Entry Name	Object Class Term	Property Term	Object Class Term	Property Term	Cardinality
HK Physical Address. Details	ABIE	Address of a location in Hong Kong which can physically locate an organization or individual	COM00050	HK Physical Address. Details	HK Physical Address	Details	HK Physical Address	Details	
HK Physical Address. Flat. Name	BBIE	Flat or room number in a Hong Kong physical address	COM00051	HK Physical Address. Flat. Name	HK Physical Address	Flat	HK Physical Address	Flat	0-1
HK Physical Address. Floor. Name	BBIE	Floor number in a Hong Kong physical address	COM00052	HK Physical Address. Floor. Name	HK Physical Address	Floor	HK Physical Address	Floor	0-1
HK Physical Address. Block. Name	BBIE	Block name or number in a Hong Kong physical address	COM00053	HK Physical Address. Block. Name	HK Physical Address	Block	HK Physical Address	Block	0-1
HK Physical Address. Building. Name	BBIE	Building name in a Hong Kong physical address	COM00054	HK Physical Address. Building. Name	HK Physical Address	Building	HK Physical Address	Building	0-1
HK Physical Address. Estate. Name	BBIE	Estate name in a Hong Kong physical address	COM00055	HK Physical Address. Estate. Name	HK Physical Address	Estate	HK Physical Address	Estate	0-1
HK Physical Address. Street Number. Text	BBIE	Street number in a Hong Kong physical address	COM00056	HK Physical Address. Street Number. Text	HK Physical Address	Street Number	HK Physical Address	Street Number	0-1
HK Physical Address. Street. Name	BBIE	Street name in a Hong Kong physical address	COM00057	HK Physical Address. Street. Name	HK Physical Address	Street	HK Physical Address	Street	0-1
HK Physical Address. District. Name	BBIE	District name in a Hong Kong physical address	COM00058	HK Physical Address. District. Name	HK Physical Address	District	HK Physical Address	District	0-1
HK Physical Address. Area. Code	BBIE	Code identifying an Hong Kong area in a Hong Kong physical address	COM00059	HK Physical Address. Area. Code	HK Physical Address	Area	HK Physical Address	Area	0-1

3

4 1.5 Define Information Models

5 For those data elements that do not have a corresponding Common Schema that can be reused, the
6 business analyst needs to define an information model for each of these data elements. Before defining
7 the information model, the business analyst should make reference to relevant industry standards (such
8 as W3C’s XML Signature) and schemas defined by other e-government projects to see if there are
9 schemas suitable for reuse.

10 “Foreign Physical Address” is used as an example to illustrate how its information models are
11 developed. Instead of filling in the modelling worksheets provided in the Design Guide, the business
12 analyst has designed and used a spreadsheet, part of which is shown in , to ease capturing the
13 modelling information. This modelling spreadsheet is used as the data dictionary for developing the
14 Project Schemas. The Common Schema spreadsheet in the Central Registry may be used as a
15 reference for business analysts to design their own spreadsheet.

1 Table VII: The information models for “Foreign Physical Address”.

Dictionary Index			Dictionary Information	Object Class and Property			Representation	Format Restrictions on Content Component
UID	Dictionary Entry Name	BIE Type	Definition	Object Class Term	Property Term	Cardinality	Rep. Term / Object Class Term of asso. ABIE	Max. Len.
IEPP00007	Foreign Physical Address. Details	ABIE	Address of a location outside Hong Kong where an organization or an individual can be located	Foreign Physical Address	Details			
IEPP00008	Foreign Physical Address. Street. Text	BBIE	Room number, building name, street name and number, etc. in a foreign physical address	Foreign Physical Address	Street	1	Text	210
IEPP00009	Foreign Physical Address. City. Name	BBIE	City name in a foreign physical address	Foreign Physical Address	City	1	Name	35
IEPP00010	Foreign Physical Address. Country	ASBIE	Country identification in a foreign physical address	Foreign Physical Address	Country	1	Country	

2

3 **1.5.1. Sample User Document**

4 The information model developed by the business analyst needs to be shown to the business users to
 5 verify that relevant business requirements have been reflected in the model. In order to communicate
 6 with users, the business analyst may construct additional user documentation from the modelling
 7 spreadsheet. The documentation can be used for users to verify and finally sign off the information
 8 models produced by the business analyst. This section shows a sample part of the user documentation,
 9 which can be generated from the spreadsheet by a simple software program.

10 In this sample user documentation, each ABIE is summarized with its dictionary entry information,
 11 and its schema structure. Documentation parts for Import Licence. Document, Export
 12 Licence. Document, and Licence Issuing Information. Details are illustrated below.

13

14

1

Dictionary Entry Information

Dictionary Entry Name: Import Licence. Document

UID: IEPP00101

Version: 1.0

Maturity Level: Draft

Definition: A trade document issued by the Hong Kong SAR Government which grants the authority to import certain commodities or goods to Hong Kong

2

Schema Structure

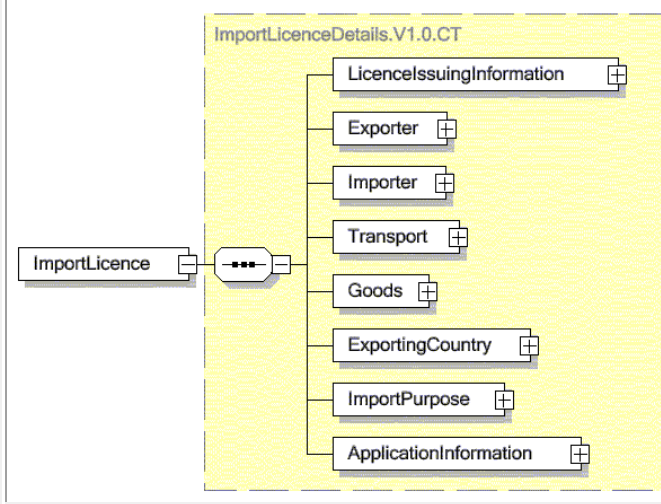

3

4

Dictionary Entry Information

Dictionary Entry Name: Export Licence. Document

UID: IEPP00102

Version: 1.0

Maturity Level: Draft

Definition: A trade document issued by the Hong Kong SAR Government which grants the authority to export certain commodities or goods from Hong Kong

5

6

Schema Structure

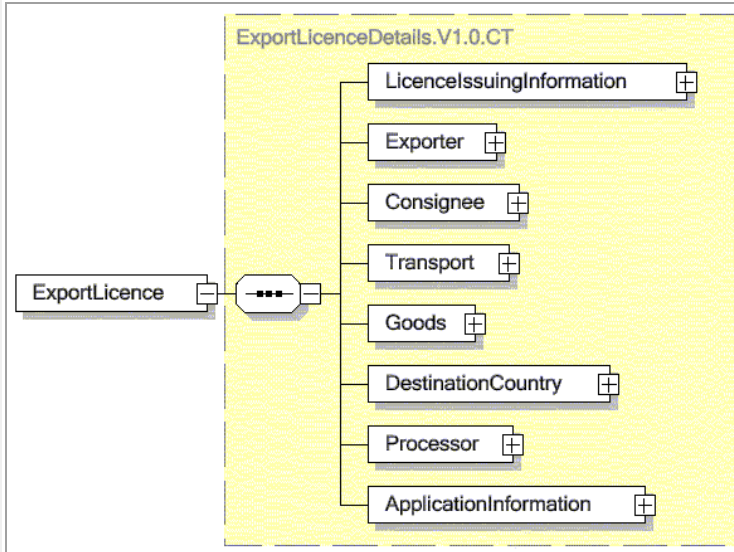

7

1

Dictionary Entry Information		
Dictionary Entry Name: Licence Issuing Information. Details		
UID: IEPP00001	Version: 1.0	Maturity Level: Draft
Definition: Issuing information of a licence document, e.g. issue date and licence number		

2

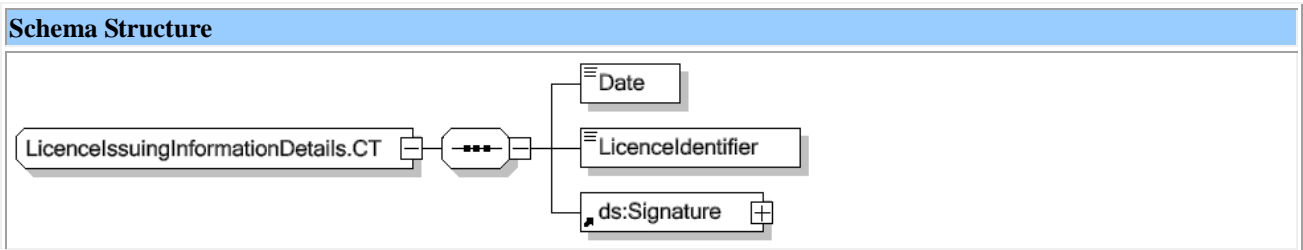

3

Basic BIE Details / Aggregated BIEs				
Order	UID	Dictionary Entry Name	Data Type	Cardinality
Definition			Restriction	
1	IEPP00002	Licence Issuing Information. Date	Date	1
Date on which a licence document is issued by issuing authority				
2	IEPP00003	Licence Issuing Information. Licence. Identifier	String	1
Reference number assigned by issuing authority to a licence document			Maximum Length: 17	
3	IEPP00081	Licence Issuing Information. Issuing Authority Signature. External	External	1
Signature of the issuing authority				

4

5 1.6 XML Schema Definition Development

6 This section demonstrates how the programmer converts the ABIE for “Foreign Physical Address”.

7 The ABIE, of which the Dictionary Entry Name is “Foreign Physical Address. Details”, is converted
 8 into an `xs:complexType` with the type name “ForeignPhysicalAddressDetails.CT”
 9 according to the naming rules provided in Section 5.5.1 of the Design Guide.

10 The ABIE has aggregated two BBIEs and one ASBIE, namely “Foreign Physical Address. Street.
 11 Text”, “Foreign Physical Address. City. Name”, and “Foreign Physical Address. Country”. These
 12 three aggregated BIEs are converted to become the child elements of the
 13 “ForeignPhysicalAddressDetails.CT” `xs:complexType`. Since the cardinalities of these three
 14 aggregated BBIEs are “1”, both `minOccurs` and `maxOccurs` for the child elements should be “1”.
 15 (When `minOccurs` or `maxOccurs` is not declared, its default value, which is “1”, is used.)

16 The names of these child elements are “Street”, “City” and “Country”, which are the Property
 17 Terms of the aggregated BIEs. For the aggregated BBIEs, the child elements are based on the
 18 `xs:complexTypes` for those BBIEs. For the aggregated ASBIE, the child element is based on the
 19 `xs:complexType` of the ABIE with which that ASBIE is associated.

20 A tool is provided in the Central Registry to convert information models in the spreadsheet to XSD.
 21 Before such conversion, the programmer needs to provide some supporting information on the
 22 spreadsheet such as the regular expression for a pattern, the use of an Externally Defined Entity to link
 23 up an external industry standard (such as W3C’s XML Signature), etc.

24

1 Table VIII: Sample conversion from the “Foreign Physical Address” ABIE to XSD code.

<i>Dictionary Entry Name</i>	<i>BIE Type</i>	<i>Cardinality</i>	<i>Order</i>	<i>Complex Type Name</i>	<i>Element Name</i>	<i>Min-occurs</i>	<i>Max-occurs</i>
Foreign Physical Address. Details	ABIE	n/a	n/a	ForeignPhysicalAddressDetails.CT	n/a	n/a	n/a
Foreign Physical Address. Street. Text	BBIE	1	1	ForeignPhysicalAddressStreetText.CT	Street	1	1
Foreign Physical Address. City. Name	BBIE	1	2	ForeignPhysicalAddressCityName.CT	City	1	1
Foreign Physical Address. Country	ASBIE	1	3	CountryDetails.CT (the xs:complexType of the ABIE with which this ASBIE is associated)	Country	1	1

2

```

<xs:complexType name="ForeignPhysicalAddressDetails.CT">
  <xs:sequence>
    <xs:element name="Street" type="ForeignPhysicalAddressStreetText.CT"/>
    <xs:element name="City" type="ForeignPhysicalAddressCityName.CT"/>
    <xs:element name="Country" type="CountryDetails.CT"/>
  </xs:sequence>
</xs:complexType>

```

3 **1.7 Organize Information Models and XML Schema Definitions in the Project**
4 **Registry**

5 All information models are then organized using a data dictionary (which can be in the form of a
6 spreadsheet or a database). The data dictionary and the XSDs are then stored in the Project Registry.

7 Section 1.7.1 illustrates all information models captured in the modelling spreadsheet.

8 Section 1.7.2 shows the structures of the three documents.

9 Section 1.7.3 lists the XSD code for these three documents.

1 **1.7.1. Information Models**

Dictionary Index				Dictionary Information	Reuse of Common Schema		Object Class and Property			Representation	Format Restrictions on Content Component				Supplementary Components				
UID	Dictionary Entry Name	Business Terms	BIE Type	Definition	UID	Dictionary Entry Name	Object Class Term	Property Term	Cardinality	Rep. Term / Object Class Term of asso. ABIE	Len.	Max. Len.	Tot. Digits	Frac. Digits	Agency ID	Agency Name	Code List ID	Code List Name	Currency Code
IEPP00001	Licence Issuing Information. Details		ABIE	Issuing information of a licence document, e.g. issue date and licence number			Licence Issuing Information	Details											
IEPP00002	Licence Issuing Information. Date		BBIE	Date on which a licence document is issued by issuing authority			Licence Issuing Information	Date	1	Date									
IEPP00003	Licence Issuing Information. Licence. Identifier	Licence Number	BBIE	Reference number assigned by issuing authority to a licence document			Licence Issuing Information	Licence Identifier	1	Identifier		17							
IEPP00008 ¹	Licence Issuing Information. Issuing Authority Signature. External		ASBIE	Signature of the issuing authority			Licence Issuing Information	Issuing Authority Signature	1	External									
IEPP00004	Country. Details		ABIE	Identification of a country or other geographical entity as specified in ISO 3166	COM0 0001	Country. Details	Country	Details											
IEPP00005	Country. Name		BBIE	Name of a country or other geographical entity as specified in ISO 3166	COM0 0002	Country. Name	Country	Name	0-1	Name		35							
IEPP00006	Country. Code		BBIE	Code identifying the name of the country or other geographical entity as specified in ISO 3166	COM0 0003	Country. Code	Country	Code	0-1	Code	2					ISO		ISO 3166-1	
IEPP00007	Foreign Physical Address. Details		ABIE	Address of a location outside Hong Kong where an organization or an individual can be located			Foreign Physical Address	Details											
IEPP00008	Foreign Physical Address. Street. Text		BBIE	Room number, building name, street name and number, etc. in a foreign physical address			Foreign Physical Address	Street	1	Text		210							
IEPP00009	Foreign Physical Address. City. Name		BBIE	City name in a foreign physical address			Foreign Physical Address	City	1	Name		35							
IEPP00010	Foreign Physical Address. Country		ASBIE	Country identification in a foreign physical address			Foreign Physical Address	Country	1	Country									

2

¹ With regard to the “Licence Issuing Information. Issuing Authority Signature. External” under “Licence Issuing Information. Details”, the programmer should adopt W3C’s XML Signature standard. The programmer should study the XML Signature specification and decide how he / she should link up the import / export document to the XML Signature schema. In this case, the element reference method should be used to encode XSD. The programmer should fill in the spreadsheet with relevant information (i.e. `<xs:element ref="ds:Signature"/>`) before generating XSD from the spreadsheet. The schema document should also import the XML Signature XSD from <http://www.w3.org/TR/2002/REC-xmlsig-core-20020212/xmlsig-core-schema.xsd> and declare the namespace `xmlns:ds="http://www.w3.org/2000/09/xmlsig#"`.

1

Dictionary Index				Dictionary Information	Reuse of Common Schema		Object Class and Property			Representation	Format Restrictions on Content Component				Supplementary Components					
UID	Dictionary Entry Name	Business Terms	BIE Type	Definition	UID	Dictionary Entry Name	Object Class Term	Property Term	Cardinality	Rep. Term / Object Class Term of asso. ABIE	Len.	Max. Len.	Tot. Digits	Frac. Digits	Agency ID	Agency Name	Code List ID	Code List Name	Currency Code	
IEPP00011	HK Physical Address. Details		ABIE	Address of a location in Hong Kong where an organization or an individual can be located	COM0 0050	HK Physical Address. Details	HK Physical Address	Details												
IEPP00012	HK Physical Address. Flat. Name		BBIE	Flat or room number in a Hong Kong physical address	COM0 0051	HK Physical Address. Flat. Name	HK Physical Address	Flat	0-1	Name		17								
IEPP00013	HK Physical Address. Floor. Name		BBIE	Floor number in a Hong Kong physical address	COM0 0052	HK Physical Address. Floor. Name	HK Physical Address	Floor	0-1	Name		17								
IEPP00014	HK Physical Address. Block. Name		BBIE	Block name or number in a Hong Kong physical address	COM0 0053	HK Physical Address. Block. Name	HK Physical Address	Block	0-1	Name		17								
IEPP00015	HK Physical Address. Building. Name		BBIE	Building name in a Hong Kong physical address	COM0 0054	HK Physical Address. Building. Name	HK Physical Address	Building	0-1	Name		70								
IEPP00016	HK Physical Address. Estate. Name		BBIE	Estate name in a Hong Kong physical address	COM0 0055	HK Physical Address. Estate. Name	HK Physical Address	Estate	0-1	Name		35								
IEPP00017	HK Physical Address. Street Number. Text		BBIE	Street number in a Hong Kong physical address	COM0 0056	HK Physical Address. Street Number. Text	HK Physical Address	Street Number	0-1	Text		35								
IEPP00018	HK Physical Address. Street. Name		BBIE	Street name in a Hong Kong physical address	COM0 0057	HK Physical Address. Street. Name	HK Physical Address	Street	0-1	Name		70								
IEPP00019	HK Physical Address. District. Name		BBIE	District name in a Hong Kong physical address	COM0 0058	HK Physical Address. District. Name	HK Physical Address	District	0-1	Name		35								
IEPP00020	HK Physical Address. Area. Code		BBIE	Code identifying an Hong Kong area in a Hong Kong physical address	COM0 0059	HK Physical Address. Area. Code	HK Physical Address	Area	0-1	Code	2				http://www.xml.gov.hk	HKSA RG			HKSA R AREA CODE LIST	
IEPP00021	Hong Kong Party. Details		ABIE	Details of an organization or individual residing in Hong Kong			Hong Kong Party	Details												
IEPP00022	Hong Kong Party. Name		BBIE	Name of an organization or individual residing in Hong Kong			Hong Kong Party	Name	1	Name		70								
IEPP00023	Hong Kong Party. HK Physical Address		ASBIE	Address of an organization or individual residing in Hong Kong			Hong Kong Party	Address	1	HK Physical Address										
IEPP00024	Hong Kong Party. Identifier	BR Number, HKID Number	BBIE	Identification of an organization or individual residing in Hong Kong			Hong Kong Party	Identifier	1	Identifier		17								
IEPP00025	Hong Kong Party. Telephone Number. Text		BBIE	Telephone number which can be used to contact an organization or individual residing in Hong Kong			Hong Kong Party	Telephone Number	1	Text		35								

2

3

1

Dictionary Index				Dictionary Information	Reuse of Common Schema		Object Class and Property			Representation	Format Restrictions on Content Component				Supplementary Components					
UID	Dictionary Entry Name	Business Terms	BIE Type	Definition	UID	Dictionary Entry Name	Object Class Term	Property Term	Cardinality	Rep. Term / Object Class Term of asso. ABIE	Len.	Max. Len.	Tot. Digits	Frac. Digits	Agency ID	Agency Name	Code List ID	Code List Name	Currency Code	
IEPP00026	Foreign Party. Details		ABIE	Details of an organization or individual residing outside Hong Kong			Foreign Party	Details												
IEPP00027	Foreign Party. Name		BBIE	Name of an organization or individual residing outside Hong Kong			Foreign Party	Name	1	Name		70								
IEPP00028	Foreign Party. Foreign Physical Address		ASBIE	Physical address of an organization or individual residing outside Hong Kong			Foreign Party	Address	1	Foreign Physical Address										
IEPP00029	Transport. Details		ABIE	Details of transportation of goods			Transport	Details												
IEPP00030	Transport. Mode. Code		BBIE	Method of transportation			Transport	Mode	1	Code		3			http://www.unece.org	UNECE		UNECE Rec. 19		
IEPP00031	Transport. Vessel. Name		BBIE	Name of a vessel or carrier with which goods are transported			Transport	Vessel Name	0-1	Name		70								
IEPP00032	Transport. Vessel. Identifier		BBIE	Identification of a vessel or carrier with which goods are transported			Transport	Vessel Identifier	0-1	Identifier		17								
IEPP00033	Transport. Arrival. Date		BBIE	Date on which a vessel or carrier arrives at a concerned port (e.g. Hong Kong)			Transport	Arrival Date	0-1	Date										
IEPP00034	Transport. Departure. Date		BBIE	Date on which a vessel or carrier departs from a concerned port (e.g. Hong Kong)			Transport	Departure Date	0-1	Date										
IEPP00035	Goods Item. Details		ABIE	Details of a goods item			Goods Item	Details												
IEPP00036	Goods Item. Marks Numbers. Text		BBIE	Shipping marks and numbers marked on a package of goods			Goods Item	Marks Numbers	0-1	Text		70								
IEPP00037	Goods Item. Container. Identifier		BBIE	Identification of a container			Goods Item	Container Identifier	0-1	Identifier		17								
IEPP00038	Goods Item. Package. Quantity		BBIE	Number of packages of a goods item			Goods Item	Package Quantity	1	Quantity			17	3						
IEPP00039	Goods Item. Brand Model. Name		BBIE	Brand name and model name of a goods item			Goods Item	Brand Model	0-1	Name		70								
IEPP00040	Goods Item. Description. Text		BBIE	Description of a goods item			Goods Item	Description	1	Text		210								
IEPP00041	Goods Item. Unit. Quantity		BBIE	Quantity of a goods item in a proper unit			Goods Item	Unit Quantity	1	Quantity			17	3						
IEPP00042	Goods Item. CIF Value. Amount		BBIE	Cost-Insurance-Freight (CIF) value of a goods item			Goods Item	CIF Value	0-1	Amount			35	3						HKD
IEPP00043	Goods Item. FOB Value. Amount		BBIE	Free on Board (FOB) value of a goods item			Goods Item	FOB Value	0-1	Amount			35	3						
IEPP00044	Goods Item. Origin. Country		ASBIE	Country of origin of a goods item			Goods Item	Origin Country	1	Country										
IEPP00045	Goods. Details		ABIE	Goods declared on a trade document (e.g. import or export licence)			Goods	Details												
IEPP00046	Goods. Goods Item		ASBIE	Details of one goods item entry on a licence document			Goods	Item	1-99	Goods Item										
IEPP00047	Goods. Total CIF Value. Amount		BBIE	Total Cost-Insurance-Freight (CIF) value of goods			Goods	Total CIF Value	0-1	Amount			35	3						HKD
IEPP00048	Goods. Total FOB Value. Amount		BBIE	Total Free on Board (FOB) value of goods			Goods	Total FOB Value	0-1	Amount			35	3						

2

Dictionary Index				Dictionary Information	Reuse of Common Schema	Object Class and Property			Representation	Format Restrictions on Content Component				Supplementary Components						
UID	Dictionary Entry Name	Business Terms	BIE Type	Definition	UID	Dictionary Entry Name	Object Class Term	Property Term	Cardinality	Rep. Term / Object Class Term of asso. ABIE	Len.	Max. Len.	Tot. Digits	Frac. Digits	Agency ID	Agency Name	Code List ID	Code List Name	Currency Code	
IEPP00049	Application Information. Details		ABIE	Information on an application for a licence document			Application Information	Details												
IEPP00050	Application Information. Date		BBIE	Date on which a licence application is submitted			Application Information	Date	1	Date										
IEPP00051	Application Information. Applicant. Name		BBIE	Name of an individual who submits a licence application			Application Information	Applicant Name	1	Name		70								
IEPP00080 ²	Application Information. Applicant Signature. External		ASBIE	Signature of an individual who submits a licence application			Application Information	Applicant Signature	1	External										
IEPP00052	Import Purpose. Details		ABIE	Purpose for which goods are imported			Import Purpose	Details												
IEPP00053	Import Purpose. Local Consumption. Boolean		BBIE	Indication whether goods are imported for local consumption			Import Purpose	Local Consumption	1	Boolean										
IEPP00054	Import Purpose. Reexport To. Country		ASBIE	Country to which goods are reexported			Import Purpose	Reexport To Country	0-1	Country										
IEPP00055	Import Licence. Details	Form 3, TRA 187	ABIE	A trade document issued by the Hong Kong SAR Government which grants the authority to import certain commodities or goods to Hong Kong			Import Licence	Details												
IEPP00056	Import Licence. Licence Issuing Information		ASBIE	Issuing information of an import licence			Import Licence	Licence Issuing Information	0-1	Licence Issuing Information										
IEPP00057	Import Licence. Exporter. Foreign Party		ASBIE	Details of a foreign organization or individual who exports goods to Hong Kong			Import Licence	Exporter	1	Foreign Party										
IEPP00058	Import Licence. Importer. Hong Kong Party		ASBIE	Details of a Hong Kong organization or individual who imports goods to Hong Kong			Import Licence	Importer	1	Hong Kong Party										
IEPP00059	Import Licence. Transport		ASBIE	Details of transportation of goods			Import Licence	Transport	1	Transport										
IEPP00060	Import Licence. Goods		ASBIE	Details of goods for import to Hong Kong			Import Licence	Goods	1	Goods										
IEPP00061	Import Licence. Exporting. Country		ASBIE	Country from which goods are exported to Hong Kong			Import Licence	Exporting Country	1	Country										
IEPP00062	Import Licence. Import Purpose		ASBIE	Purpose for which goods are imported			Import Licence	Import Purpose	1	Import Purpose										
IEPP00063	Import Licence. Application Information		ASBIE	Information of application for a licence document			Import Licence	Application Information	1	Application Information										

1

² With regard to the “Application Information. Applicant Signature. External” under “Application Information. Details”, the programmer should adopt W3C’s XML Signature standard. The programmer should study the XML Signature specification and decide how he / she should link up the import / export document to the XML Signature schema. In this case, the element reference method should be used to encode XSD. The programmer should fill in the spreadsheet with relevant information (i.e. `<xs:element ref="ds:Signature"/>`) before generating XSD from the spreadsheet. The schema document should also import the XML Signature XSD from <http://www.w3.org/TR/2002/REC-xmlsig-core-20020212/xmlsig-core-schema.xsd> and declare the namespace `xmlns:ds="http://www.w3.org/2000/09/xmlsig#"`.

1

Dictionary Index				Dictionary Information	Reuse of Common Schema		Object Class and Property			Representation	Format Restrictions on Content Component				Supplementary Components					
UID	Dictionary Entry Name	Business Terms	BIE Type	Definition	UID	Dictionary Entry Name	Object Class Term	Property Term	Cardinality	Rep. Term / Object Class Term of asso. ABIE	Len.	Max. Len.	Tot. Digits	Frac. Digits	Agency ID	Agency Name	Code List ID	Code List Name	Currency Code	
IEPP00064	Export Licence. Details	Form 6, TRA 394	ABIE	A trade document issued by the Hong Kong SAR Government which grants the authority to export certain commodities or goods from Hong Kong			Export Licence	Details												
IEPP00065	Export Licence. Licence Issuing Information		ASBIE	Issuing information of an export licence			Export Licence	Licence Issuing Information	0-1	Licence Issuing Information										
IEPP00066	Export Licence. Exporter. Hong Kong Party		ASBIE	Details of a Hong Kong organization or individual who exports goods from Hong Kong			Export Licence	Exporter	1	Hong Kong Party										
IEPP00067	Export Licence. Consignee. Foreign Party		ASBIE	A foreign organization or individual to whom exported goods will be shipped to			Export Licence	Consignee	1	Foreign Party										
IEPP00068	Export Licence. Transport		ASBIE	Details of transportation of goods			Export Licence	Transport	1	Transport										
IEPP00069	Export Licence. Goods		ASBIE	Details of goods for export from Hong Kong			Export Licence	Goods	1	Goods										
IEPP00070	Export Licence. Destination. Country		ASBIE	Country to which goods are exported			Export Licence	Destination Country	1	Country										
IEPP00071	Export Licence. Processor. Hong Kong Party		ASBIE	Details of a manufacturer or processor of goods for export			Export Licence	Processor	0-1	Hong Kong Party										
IEPP00072	Export Licence. Application Information		ASBIE	Information on an application for an export licence			Export Licence	Application Information	1	Application Information										
IEPP00073	Error. Details		ABIE	Details of an error which occurs on processing a request			Error	Details												
IEPP00074	Error. Type. Code		BBIE	Code identifying a processing error			Error	Type	1	Code										
IEPP00075	Error. Message. Text		BBIE	Textual description providing explanation to a processing error			Error	Message	1	Text		210								
IEPP00076	Acknowledgement. Details		ABIE	Acknowledgement message for application, approval, and issue of a licence document			Acknowledgement	Details												
IEPP00077	Acknowledgement. Type. Code		BBIE	Code identifying an acknowledgement type			Acknowledgement	Type	1	Code	2				http://www.xml.gov.hk	HKSAR G		ACKNOWLEDGEMENT TYPE CODE LIST		
IEPP00078	Acknowledgement. Message. Text		BBIE	Textual description providing explanation to an acknowledgement message			Acknowledgement	Message	0-1	Text		210								
IEPP00079	Acknowledgement. Error		ASBIE	Details of an error which occurs on processing a request			Acknowledgement	Error	0-99	Error										
IEPP00080	Import Licence. Document		Document	The data of an import licence application or the licence issued			Import Licence	Document		Import Licence										
IEPP00081	Export Licence. Document		Document	The data of an export licence application or the licence issued			Export Licence	Document		Export Licence										
IEPP00082	Acknowledgement. Document		Document	The status of a licence application			Acknowledgement	Document		Acknowledgement										

2

3

1 **1.7.2. Document Structures and XML Schema Definition**

2 **1.7.2.1. Structure of Import Licence Document**

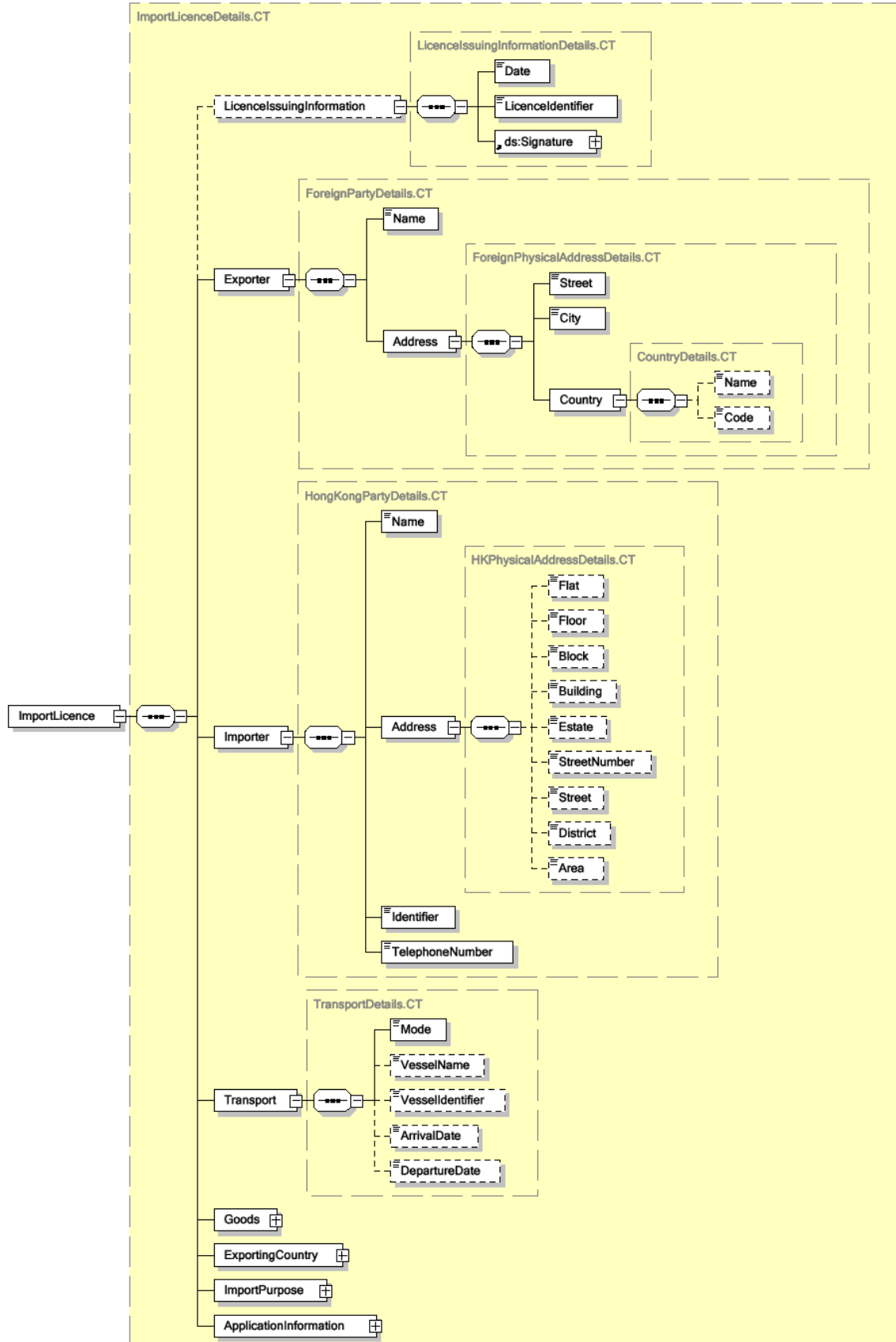

1
2

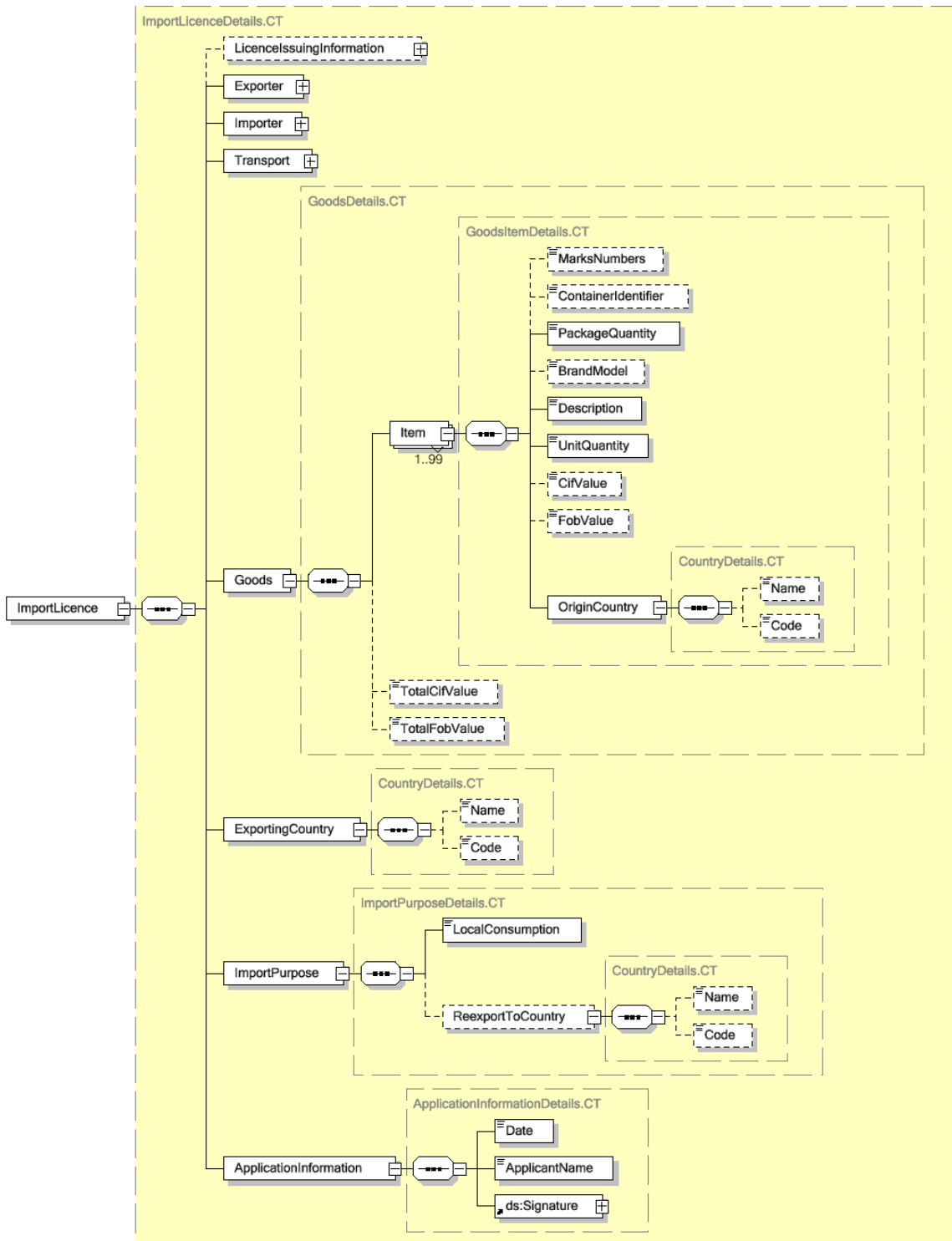

3
4

1 1.7.2.2. Structure of Export Licence Document

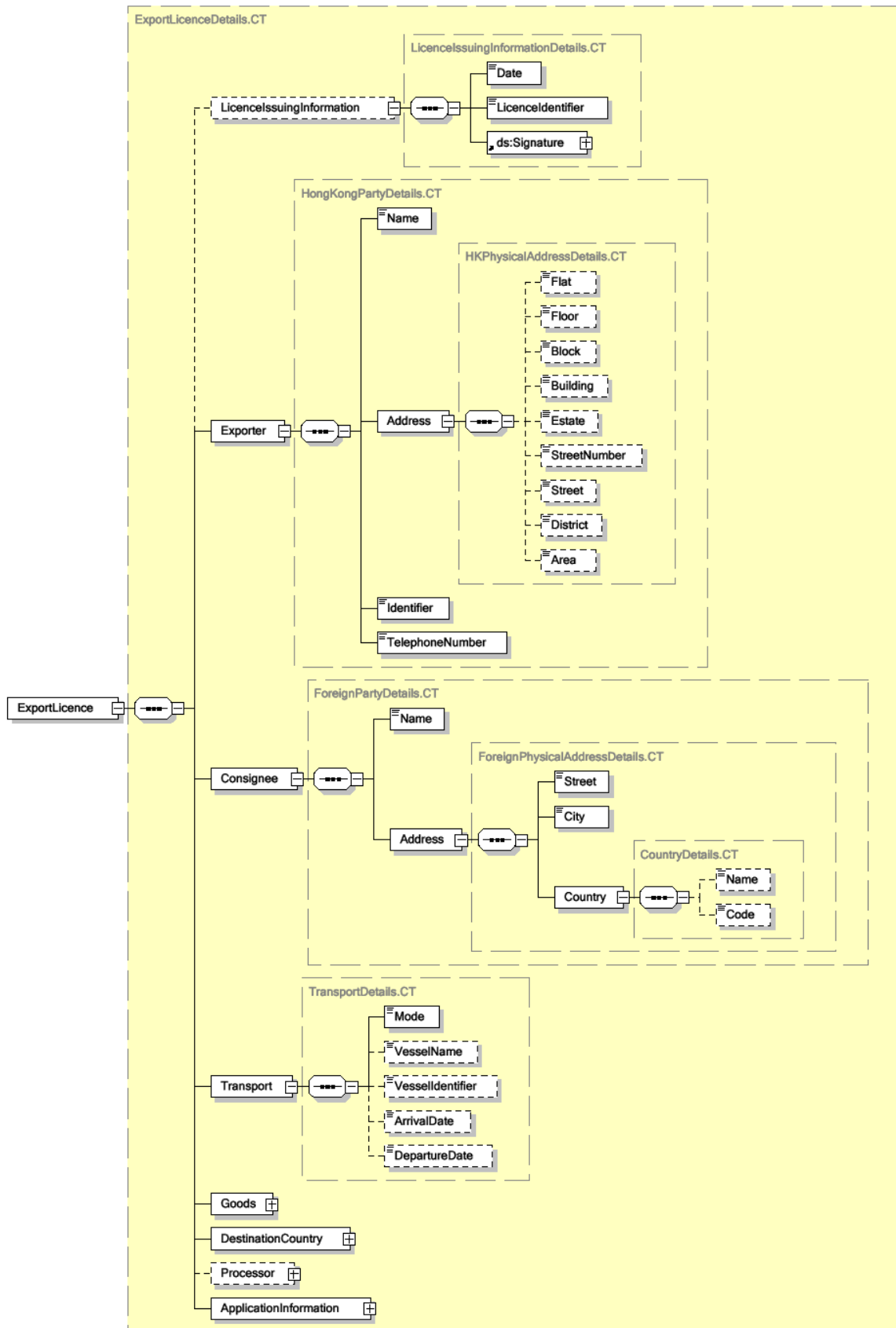

2
3

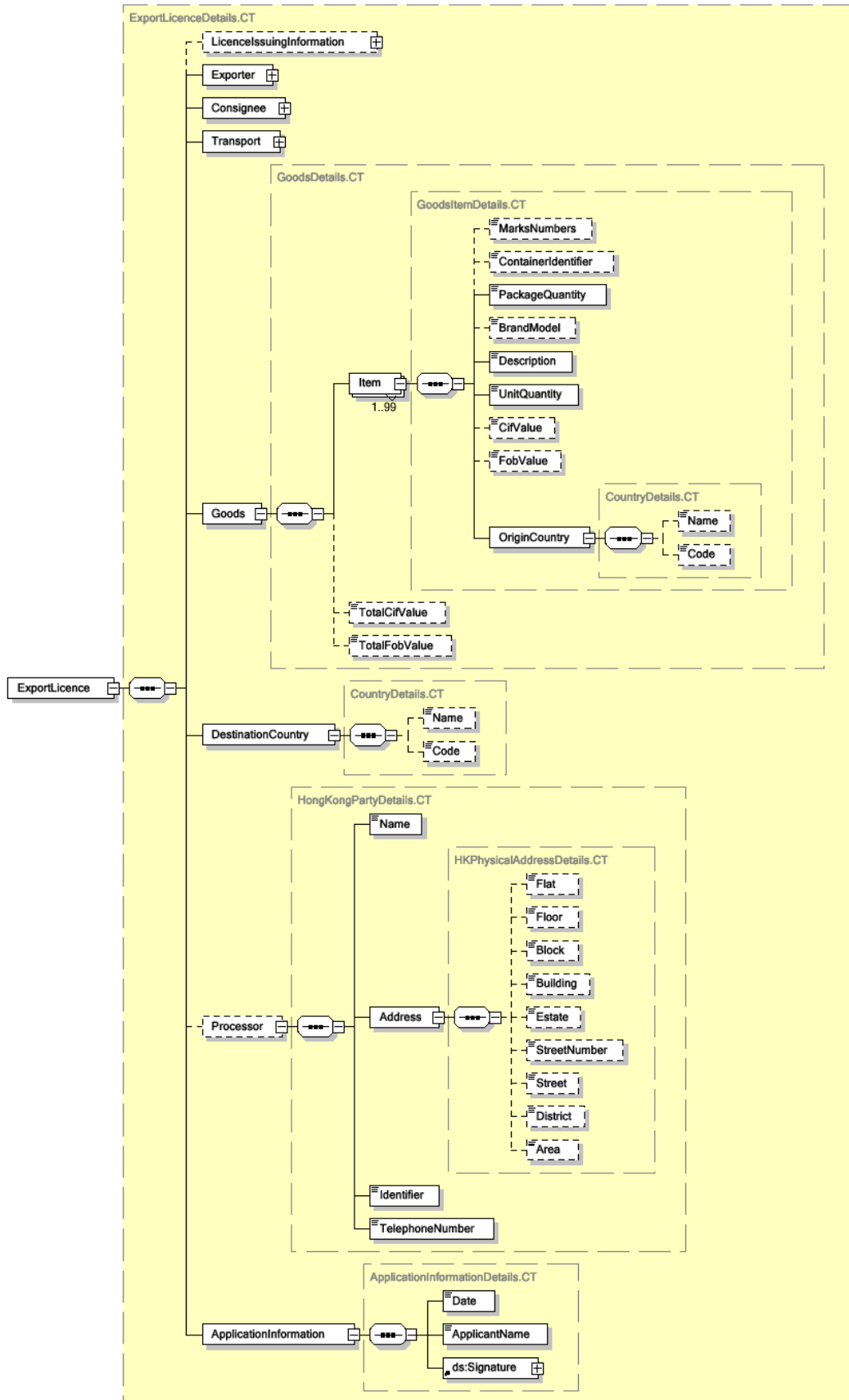

1 **1.7.2.3. Structure of Acknowledgement Document**

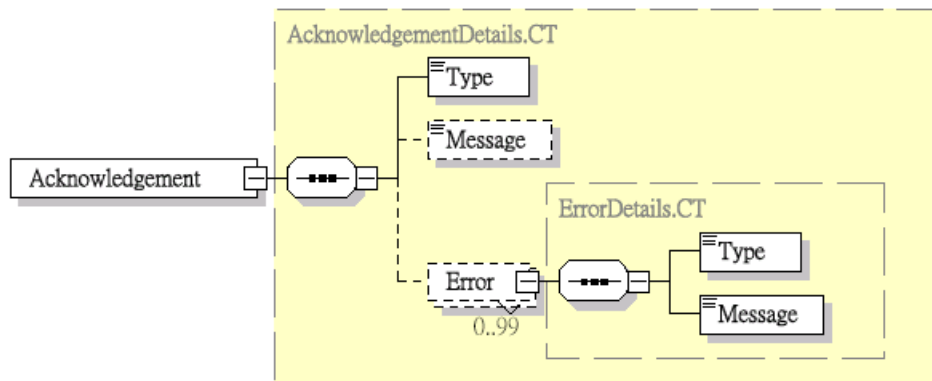

2
3
4

1.7.3. XML Schema Definitions

The following pages show XSD code translated from the information models specified in 1.7.1.

```
<?xml version="1.0" encoding="UTF-8"?>
<xs:schema xmlns:ds="http://www.w3.org/2000/09/xmldsig#"
xmlns:cct="http://www.xml.gov.hk/schemas/cct"
xmlns:xs="http://www.w3.org/2001/XMLSchema" elementFormDefault="qualified"
attributeFormDefault="unqualified">
  <xs:import namespace="http://www.xml.gov.hk/schemas/cct"
schemaLocation="http://www.xml.gov.hk/schemas/cct/cct.xsd"/>
  <xs:import namespace="http://www.w3.org/2000/09/xmldsig#"
schemaLocation="http://www.w3.org/TR/2002/REC-xmldsig-core-20020212/
xmldsig-core-schema.xsd"/>
  <xs:annotation>
    <xs:documentation>Shared BIEs</xs:documentation>
  </xs:annotation>
  <xs:complexType name="CountryDetails.CT">
    <xs:sequence>
      <xs:element name="Name" type="CountryName.CT" minOccurs="0"/>
      <xs:element name="Code" type="CountryCode.CT" minOccurs="0"/>
    </xs:sequence>
  </xs:complexType>
  <xs:complexType name="CountryName.CT">
    <xs:simpleContent>
      <xs:restriction base="cct:Name.CT">
        <xs:maxLength value="35"/>
      </xs:restriction>
    </xs:simpleContent>
  </xs:complexType>
  <xs:complexType name="CountryCode.CT">
    <xs:simpleContent>
      <xs:restriction base="cct:Code.CT">
        <xs:length value="2"/>
        <xs:attribute name="agencyId" default="http://www.iso.ch">
          <xs:simpleType>
            <xs:restriction base="xs:token">
              <xs:enumeration value="http://www.iso.ch"/>
            </xs:restriction>
          </xs:simpleType>
        </xs:attribute>
        <xs:attribute name="agencyName" default="ISO">
          <xs:simpleType>
            <xs:restriction base="xs:token">
              <xs:enumeration value="ISO"/>
            </xs:restriction>
          </xs:simpleType>
        </xs:attribute>
        <xs:attribute name="codeListId"
default="http://www.iso.ch/iso/en/prods-services/iso3166ma/index.html">
          <xs:simpleType>
            <xs:restriction base="xs:token">
              <xs:enumeration value="http://www.iso.ch/iso/en/prods-
services/iso3166ma/index.html"/>
            </xs:restriction>
          </xs:simpleType>
        </xs:attribute>
        <xs:attribute name="codeListName" default="ISO 3166-1">
          <xs:simpleType>
            <xs:restriction base="xs:token">
```

```
1         <xs:enumeration value="ISO 3166-1"/>
2     </xs:restriction>
3 </xs:simpleType>
4 </xs:attribute>
5 </xs:restriction>
6 </xs:simpleContent>
7 </xs:complexType>
8 <xs:complexType name="ForeignPhysicalAddressDetails.CT">
9     <xs:sequence>
10        <xs:element name="Street"
11 type="ForeignPhysicalAddressStreetText.CT"/>
12        <xs:element name="City" type="ForeignPhysicalAddressCityName.CT"/>
13        <xs:element name="Country" type="CountryDetails.CT"/>
14    </xs:sequence>
15 </xs:complexType>
16 <xs:complexType name="ForeignPhysicalAddressStreetText.CT">
17     <xs:simpleContent>
18         <xs:restriction base="cct:Text.CT">
19             <xs:maxLength value="210"/>
20         </xs:restriction>
21     </xs:simpleContent>
22 </xs:complexType>
23 <xs:complexType name="ForeignPhysicalAddressCityName.CT">
24     <xs:simpleContent>
25         <xs:restriction base="cct:Name.CT">
26             <xs:maxLength value="35"/>
27         </xs:restriction>
28     </xs:simpleContent>
29 </xs:complexType>
30 <xs:complexType name="HKPhysicalAddressDetails.CT">
31     <xs:sequence>
32        <xs:element name="Flat" type="HKPhysicalAddressFlatName.CT"
33 minOccurs="0"/>
34        <xs:element name="Floor" type="HKPhysicalAddressFloorName.CT"
35 minOccurs="0"/>
36        <xs:element name="Block" type="HKPhysicalAddressBlockName.CT"
37 minOccurs="0"/>
38        <xs:element name="Building" type="HKPhysicalAddressBuildingName.CT"
39 minOccurs="0"/>
40        <xs:element name="Estate" type="HKPhysicalAddressEstateName.CT"
41 minOccurs="0"/>
42        <xs:element name="StreetNumber"
43 type="HKPhysicalAddressStreetNumberText.CT" minOccurs="0"/>
44        <xs:element name="Street" type="HKPhysicalAddressStreetName.CT"
45 minOccurs="0"/>
46        <xs:element name="District" type="HKPhysicalAddressDistrictName.CT"
47 minOccurs="0"/>
48        <xs:element name="Area" type="HKPhysicalAddressAreaCode.CT"
49 minOccurs="0"/>
50    </xs:sequence>
51 </xs:complexType>
52 <xs:complexType name="HKPhysicalAddressFlatName.CT">
53     <xs:simpleContent>
54         <xs:restriction base="cct:Name.CT">
55             <xs:maxLength value="17"/>
56         </xs:restriction>
57     </xs:simpleContent>
58 </xs:complexType>
59 <xs:complexType name="HKPhysicalAddressFloorName.CT">
60     <xs:simpleContent>
61         <xs:restriction base="cct:Name.CT">
```

```
1         <xs:maxLength value="17"/>
2     </xs:restriction>
3 </xs:simpleContent>
4 </xs:complexType>
5 <xs:complexType name="HKPhysicalAddressBlockName.CT">
6     <xs:simpleContent>
7         <xs:restriction base="cct:Name.CT">
8             <xs:maxLength value="17"/>
9         </xs:restriction>
10    </xs:simpleContent>
11 </xs:complexType>
12 <xs:complexType name="HKPhysicalAddressBuildingName.CT">
13     <xs:simpleContent>
14         <xs:restriction base="cct:Name.CT">
15             <xs:maxLength value="70"/>
16         </xs:restriction>
17    </xs:simpleContent>
18 </xs:complexType>
19 <xs:complexType name="HKPhysicalAddressEstateName.CT">
20     <xs:simpleContent>
21         <xs:restriction base="cct:Name.CT">
22             <xs:maxLength value="35"/>
23         </xs:restriction>
24    </xs:simpleContent>
25 </xs:complexType>
26 <xs:complexType name="HKPhysicalAddressStreetNumberText.CT">
27     <xs:simpleContent>
28         <xs:restriction base="cct:Text.CT">
29             <xs:maxLength value="35"/>
30         </xs:restriction>
31    </xs:simpleContent>
32 </xs:complexType>
33 <xs:complexType name="HKPhysicalAddressStreetName.CT">
34     <xs:simpleContent>
35         <xs:restriction base="cct:Name.CT">
36             <xs:maxLength value="70"/>
37         </xs:restriction>
38    </xs:simpleContent>
39 </xs:complexType>
40 <xs:complexType name="HKPhysicalAddressDistrictName.CT">
41     <xs:simpleContent>
42         <xs:restriction base="cct:Name.CT">
43             <xs:maxLength value="35"/>
44         </xs:restriction>
45    </xs:simpleContent>
46 </xs:complexType>
47 <xs:complexType name="HKPhysicalAddressAreaCode.CT">
48     <xs:simpleContent>
49         <xs:restriction base="cct:Code.CT">
50             <xs:length value="2"/>
51             <xs:attribute name="agencyId" default="http://www.xml.gov.hk">
52                 <xs:simpleType>
53                     <xs:restriction base="xs:token">
54                         <xs:enumeration value="http://www.xml.gov.hk"/>
55                     </xs:restriction>
56                 </xs:simpleType>
57             </xs:attribute>
58             <xs:attribute name="agencyName" default="HKSARG">
59                 <xs:simpleType>
60                     <xs:restriction base="xs:token">
61                         <xs:enumeration value="HKSARG"/>

```

```
1         </xs:restriction>
2     </xs:simpleType>
3 </xs:attribute>
4     <xs:attribute name="codeListId"
5 default="http://www.xml.gov.hk/schemas/codelists/hksar_area_code_list.xml">
6         <xs:simpleType>
7             <xs:restriction base="xs:token">
8                 <xs:enumeration
9 value="http://www.xml.gov.hk/schemas/codelists/hksar_area_code_list.xml"/>
10            </xs:restriction>
11        </xs:simpleType>
12    </xs:attribute>
13    <xs:attribute name="codeListName" default="HKSAR AREA CODE LIST">
14        <xs:simpleType>
15            <xs:restriction base="xs:token">
16                <xs:enumeration value="HKSAR AREA CODE LIST"/>
17            </xs:restriction>
18        </xs:simpleType>
19    </xs:attribute>
20 </xs:restriction>
21 </xs:simpleContent>
22 </xs:complexType>
23 <xs:complexType name="HongKongPartyDetails.CT">
24     <xs:sequence>
25         <xs:element name="Name" type="HongKongPartyName.CT"/>
26         <xs:element name="Address" type="HKPhysicalAddressDetails.CT"/>
27         <xs:element name="Identifier" type="HongKongPartyIdentifier.CT"/>
28         <xs:element name="TelephoneNumber"
29 type="HongKongPartyTelephoneNumberText.CT"/>
30     </xs:sequence>
31 </xs:complexType>
32 <xs:complexType name="HongKongPartyName.CT">
33     <xs:simpleContent>
34         <xs:restriction base="cct:Name.CT">
35             <xs:maxLength value="70"/>
36         </xs:restriction>
37     </xs:simpleContent>
38 </xs:complexType>
39 <xs:complexType name="HongKongPartyIdentifier.CT">
40     <xs:simpleContent>
41         <xs:restriction base="cct:Identifier.CT">
42             <xs:maxLength value="17"/>
43         </xs:restriction>
44     </xs:simpleContent>
45 </xs:complexType>
46 <xs:complexType name="HongKongPartyTelephoneNumberText.CT">
47     <xs:simpleContent>
48         <xs:restriction base="cct:Text.CT">
49             <xs:maxLength value="35"/>
50         </xs:restriction>
51     </xs:simpleContent>
52 </xs:complexType>
53 <xs:complexType name="ForeignPartyDetails.CT">
54     <xs:sequence>
55         <xs:element name="Name" type="ForeignPartyName.CT"/>
56         <xs:element name="Address" type="ForeignPhysicalAddressDetails.CT"/>
57     </xs:sequence>
58 </xs:complexType>
59 <xs:complexType name="ForeignPartyName.CT">
60     <xs:simpleContent>
61         <xs:restriction base="cct:Name.CT">
```

```
1         <xs:maxLength value="70"/>
2     </xs:restriction>
3 </xs:simpleContent>
4 </xs:complexType>
5 <xs:complexType name="TransportDetails.CT">
6     <xs:sequence>
7         <xs:element name="Mode" type="TransportModeCode.CT"/>
8         <xs:element name="VesselName" type="TransportVesselName.CT"
9 minOccurs="0"/>
10        <xs:element name="VesselIdentifier"
11 type="TransportVesselIdentifier.CT" minOccurs="0"/>
12        <xs:element name="ArrivalDate" type="TransportArrivalDate.CT"
13 minOccurs="0"/>
14        <xs:element name="DepartureDate" type="TransportDepartureDate.CT"
15 minOccurs="0"/>
16    </xs:sequence>
17 </xs:complexType>
18 <xs:complexType name="TransportModeCode.CT">
19     <xs:simpleContent>
20         <xs:restriction base="cct:Code.CT">
21             <xs:maxLength value="3"/>
22             <xs:attribute name="agencyId" default="http://www.unece.org">
23                 <xs:simpleType>
24                     <xs:restriction base="xs:token">
25                         <xs:enumeration value="http://www.unece.org"/>
26                     </xs:restriction>
27                 </xs:simpleType>
28             </xs:attribute>
29             <xs:attribute name="agencyName" default="UNECE">
30                 <xs:simpleType>
31                     <xs:restriction base="xs:token">
32                         <xs:enumeration value="UNECE"/>
33                     </xs:restriction>
34                 </xs:simpleType>
35             </xs:attribute>
36             <xs:attribute name="codeListId"
37 default="http://www.unece.org/cefact/rec/rec19en.htm">
38                 <xs:simpleType>
39                     <xs:restriction base="xs:token">
40                         <xs:enumeration
41 value="http://www.unece.org/cefact/rec/rec19en.htm"/>
42                     </xs:restriction>
43                 </xs:simpleType>
44             </xs:attribute>
45             <xs:attribute name="codeListName" default="UNECE Rec. 19">
46                 <xs:simpleType>
47                     <xs:restriction base="xs:token">
48                         <xs:enumeration value="UNECE Rec. 19"/>
49                     </xs:restriction>
50                 </xs:simpleType>
51             </xs:attribute>
52         </xs:restriction>
53     </xs:simpleContent>
54 </xs:complexType>
55 <xs:complexType name="TransportVesselName.CT">
56     <xs:simpleContent>
57         <xs:restriction base="cct:Name.CT">
58             <xs:maxLength value="70"/>
59         </xs:restriction>
60     </xs:simpleContent>
61 </xs:complexType>
```

```
1     <xs:complexType name="TransportVesselIdentifier.CT">
2       <xs:simpleContent>
3         <xs:restriction base="cct:Identifier.CT">
4           <xs:maxLength value="17"/>
5         </xs:restriction>
6       </xs:simpleContent>
7     </xs:complexType>
8     <xs:complexType name="TransportArrivalDate.CT">
9       <xs:simpleContent>
10        <xs:extension base="cct:Date.CT"/>
11      </xs:simpleContent>
12    </xs:complexType>
13    <xs:complexType name="TransportDepartureDate.CT">
14      <xs:simpleContent>
15        <xs:extension base="cct:Date.CT"/>
16      </xs:simpleContent>
17    </xs:complexType>
18    <xs:complexType name="GoodsItemDetails.CT">
19      <xs:sequence>
20        <xs:element name="MarksNumbers" type="GoodsItemMarksNumbersText.CT"
21 minOccurs="0"/>
22        <xs:element name="ContainerIdentifier"
23 type="GoodsItemContainerIdentifier.CT" minOccurs="0"/>
24        <xs:element name="PackageQuantity"
25 type="GoodsItemPackageQuantity.CT"/>
26        <xs:element name="BrandModel" type="GoodsItemBrandModelName.CT"
27 minOccurs="0"/>
28        <xs:element name="Description" type="GoodsItemDescriptionText.CT"/>
29        <xs:element name="UnitQuantity" type="GoodsItemUnitQuantity.CT"/>
30        <xs:element name="CifValue" type="GoodsItemCifValueAmount.CT"
31 minOccurs="0" maxOccurs="1"/>
32        <xs:element name="FobValue" type="GoodsItemFobValueAmount.CT"
33 minOccurs="0" maxOccurs="1"/>
34        <xs:element name="OriginCountry" type="CountryDetails.CT"/>
35      </xs:sequence>
36    </xs:complexType>
37    <xs:complexType name="GoodsItemMarksNumbersText.CT">
38      <xs:simpleContent>
39        <xs:restriction base="cct:Text.CT">
40          <xs:maxLength value="70"/>
41        </xs:restriction>
42      </xs:simpleContent>
43    </xs:complexType>
44    <xs:complexType name="GoodsItemContainerIdentifier.CT">
45      <xs:simpleContent>
46        <xs:restriction base="cct:Identifier.CT">
47          <xs:maxLength value="17"/>
48        </xs:restriction>
49      </xs:simpleContent>
50    </xs:complexType>
51    <xs:complexType name="GoodsItemPackageQuantity.CT">
52      <xs:simpleContent>
53        <xs:restriction base="cct:Quantity.CT">
54          <xs:totalDigits value="17"/>
55          <xs:fractionDigits value="3"/>
56        </xs:restriction>
57      </xs:simpleContent>
58    </xs:complexType>
59    <xs:complexType name="GoodsItemBrandModelName.CT">
60      <xs:simpleContent>
61        <xs:restriction base="cct:Text.CT">
```

```
1         <xs:maxLength value="70"/>
2     </xs:restriction>
3 </xs:simpleContent>
4 </xs:complexType>
5 <xs:complexType name="GoodsItemDescriptionText.CT">
6     <xs:simpleContent>
7         <xs:restriction base="cct:Text.CT">
8             <xs:maxLength value="210"/>
9         </xs:restriction>
10    </xs:simpleContent>
11 </xs:complexType>
12 <xs:complexType name="GoodsItemUnitQuantity.CT">
13     <xs:simpleContent>
14         <xs:restriction base="cct:Quantity.CT">
15             <xs:totalDigits value="17"/>
16             <xs:fractionDigits value="3"/>
17         </xs:restriction>
18     </xs:simpleContent>
19 </xs:complexType>
20 <xs:complexType name="GoodsItemCifValueAmount.CT">
21     <xs:simpleContent>
22         <xs:restriction base="cct:Amount.CT">
23             <xs:totalDigits value="35"/>
24             <xs:fractionDigits value="3"/>
25             <xs:attribute name="currencyCode" default="HKD"/>
26         </xs:restriction>
27     </xs:simpleContent>
28 </xs:complexType>
29 <xs:complexType name="GoodsItemFobValueAmount.CT">
30     <xs:simpleContent>
31         <xs:restriction base="cct:Amount.CT">
32             <xs:totalDigits value="35"/>
33             <xs:fractionDigits value="3"/>
34         </xs:restriction>
35     </xs:simpleContent>
36 </xs:complexType>
37 <xs:complexType name="GoodsDetails.CT">
38     <xs:sequence>
39         <xs:element name="Item" type="GoodsItemDetails.CT" maxOccurs="99"/>
40         <xs:element name="TotalCifValue" type="GoodsTotalCifValueAmount.CT"
41 minOccurs="0"/>
42         <xs:element name="TotalFobValue" type="GoodsTotalFobValueAmount.CT"
43 minOccurs="0"/>
44     </xs:sequence>
45 </xs:complexType>
46 <xs:complexType name="GoodsTotalCifValueAmount.CT">
47     <xs:simpleContent>
48         <xs:restriction base="cct:Amount.CT">
49             <xs:totalDigits value="35" fixed="false"/>
50             <xs:fractionDigits value="3" fixed="false"/>
51             <xs:attribute name="currencyCode" default="HKD"/>
52         </xs:restriction>
53     </xs:simpleContent>
54 </xs:complexType>
55 <xs:complexType name="GoodsTotalFobValueAmount.CT">
56     <xs:simpleContent>
57         <xs:restriction base="cct:Amount.CT">
58             <xs:totalDigits value="35"/>
59             <xs:fractionDigits value="3"/>
60         </xs:restriction>
61     </xs:simpleContent>
```

```
1     </xs:complexType>
2     <xs:complexType name="LicenceIssuingInformationDetails.CT">
3         <xs:sequence>
4             <xs:element name="Date" type="LicenceIssuingInformationDate.CT"/>
5             <xs:element name="LicenceIdentifier"
6 type="LicenceIssuingInformationLicenceIdentifier.CT"/>
7             <xs:element ref="ds:Signature"/>
8         </xs:sequence>
9     </xs:complexType>
10    <xs:complexType name="LicenceIssuingInformationDate.CT">
11        <xs:simpleContent>
12            <xs:restriction base="cct:Date.CT"/>
13        </xs:simpleContent>
14    </xs:complexType>
15    <xs:complexType name="LicenceIssuingInformationLicenceIdentifier.CT">
16        <xs:simpleContent>
17            <xs:restriction base="cct:Identifier.CT">
18                <xs:maxLength value="17"/>
19            </xs:restriction>
20        </xs:simpleContent>
21    </xs:complexType>
22    <xs:complexType name="ApplicationInformationDetails.CT">
23        <xs:sequence>
24            <xs:element name="Date" type="ApplicationInformationDate.CT"/>
25            <xs:element name="ApplicantName"
26 type="ApplicationInformationApplicantName.CT"/>
27            <xs:element ref="ds:Signature"/>
28        </xs:sequence>
29    </xs:complexType>
30    <xs:complexType name="ApplicationInformationDate.CT">
31        <xs:simpleContent>
32            <xs:restriction base="cct:Date.CT"/>
33        </xs:simpleContent>
34    </xs:complexType>
35    <xs:complexType name="ApplicationInformationApplicantName.CT">
36        <xs:simpleContent>
37            <xs:restriction base="cct:Name.CT">
38                <xs:maxLength value="70"/>
39            </xs:restriction>
40        </xs:simpleContent>
41    </xs:complexType>
42    <xs:annotation>
43        <xs:documentation>Import Licence BIEs</xs:documentation>
44    </xs:annotation>
45    <xs:complexType name="ImportPurposeDetails.CT">
46        <xs:sequence>
47            <xs:element name="LocalConsumption"
48 type="ImportPurposeLocalConsumptionBoolean.CT"/>
49            <xs:element name="ReexportToCountry" type="CountryDetails.CT"
50 minOccurs="0"/>
51        </xs:sequence>
52    </xs:complexType>
53    <xs:complexType name="ImportPurposeLocalConsumptionBoolean.CT">
54        <xs:simpleContent>
55            <xs:restriction base="cct:Boolean.CT"/>
56        </xs:simpleContent>
57    </xs:complexType>
58    <xs:complexType name="ImportLicenceDetails.CT">
59        <xs:sequence>
60            <xs:element name="LicenceIssuingInformation"
61 type="LicenceIssuingInformationDetails.CT" minOccurs="0"/>
```



```
1      <xs:element name="Exporter" type="ForeignPartyDetails.CT"/>
2      <xs:element name="Importer" type="HongKongPartyDetails.CT"/>
3      <xs:element name="Transport" type="TransportDetails.CT"/>
4      <xs:element name="Goods" type="GoodsDetails.CT"/>
5      <xs:element name="ExportingCountry" type="CountryDetails.CT"/>
6      <xs:element name="ImportPurpose" type="ImportPurposeDetails.CT"/>
7      <xs:element name="ApplicationInformation"
8 type="ApplicationInformationDetails.CT"/>
9    </xs:sequence>
10  </xs:complexType>
11  <xs:annotation>
12    <xs:documentation>Export Licence BIEs</xs:documentation>
13  </xs:annotation>
14  <xs:complexType name="ExportLicenceDetails.CT">
15    <xs:sequence>
16      <xs:element name="LicenceIssuingInformation"
17 type="LicenceIssuingInformationDetails.CT" minOccurs="0"/>
18      <xs:element name="Exporter" type="HongKongPartyDetails.CT"/>
19      <xs:element name="Consignee" type="ForeignPartyDetails.CT"/>
20      <xs:element name="Transport" type="TransportDetails.CT"/>
21      <xs:element name="Goods" type="GoodsDetails.CT"/>
22      <xs:element name="DestinationCountry" type="CountryDetails.CT"/>
23      <xs:element name="Processor" type="HongKongPartyDetails.CT"
24 minOccurs="0"/>
25      <xs:element name="ApplicationInformation"
26 type="ApplicationInformationDetails.CT"/>
27    </xs:sequence>
28  </xs:complexType>
29  <xs:annotation>
30    <xs:documentation>Acknowledgement BIEs</xs:documentation>
31  </xs:annotation>
32  <xs:complexType name="ErrorDetails.CT">
33    <xs:sequence>
34      <xs:element name="Type" type="ErrorTypeCode.CT"/>
35      <xs:element name="Message" type="ErrorMessageText.CT"/>
36    </xs:sequence>
37  </xs:complexType>
38  <xs:complexType name="ErrorTypeCode.CT">
39    <xs:simpleContent>
40      <xs:restriction base="cct:Code.CT"/>
41    </xs:simpleContent>
42  </xs:complexType>
43  <xs:complexType name="ErrorMessageText.CT">
44    <xs:simpleContent>
45      <xs:restriction base="cct:Text.CT">
46        <xs:maxLength value="210"/>
47      </xs:restriction>
48    </xs:simpleContent>
49  </xs:complexType>
50  <xs:complexType name="AcknowledgementDetails.CT">
51    <xs:sequence>
52      <xs:element name="Type" type="AcknowledgementTypeCode.CT"/>
53      <xs:element name="Message" type="AcknowledgementMessageText.CT"
54 minOccurs="0"/>
55      <xs:element name="Error" type="ErrorDetails.CT" minOccurs="0"
56 maxOccurs="99"/>
57    </xs:sequence>
58  </xs:complexType>
59  <xs:complexType name="AcknowledgementTypeCode.CT">
60    <xs:simpleContent>
61      <xs:restriction base="cct:Code.CT">
```

```
1      <xs:length value="2"/>
2      <xs:attribute name="agencyId" default="http://www.xml.gov.hk">
3          <xs:simpleType>
4              <xs:restriction base="xs:token">
5                  <xs:enumeration value="http://www.xml.gov.hk"/>
6              </xs:restriction>
7          </xs:simpleType>
8      </xs:attribute>
9      <xs:attribute name="agencyName" default="HKSARG">
10         <xs:simpleType>
11             <xs:restriction base="xs:token">
12                 <xs:enumeration value="HKSARG"/>
13             </xs:restriction>
14         </xs:simpleType>
15     </xs:attribute>
16     <xs:attribute name="codeListId"
17 default="http://www.xml.gov.hk/schemas/codelists/ack_type_code_list.xml">
18         <xs:simpleType>
19             <xs:restriction base="xs:token">
20                 <xs:enumeration
21 value="http://www.xml.gov.hk/schemas/codelists/ack_type_code_list.xml"/>
22             </xs:restriction>
23         </xs:simpleType>
24     </xs:attribute>
25     <xs:attribute name="codeListName" default="ACKNOWLEDGEMENT TYPE
26 CODE LIST">
27         <xs:simpleType>
28             <xs:restriction base="xs:token">
29                 <xs:enumeration value="ACKNOWLEDGEMENT TYPE CODE LIST"/>
30             </xs:restriction>
31         </xs:simpleType>
32     </xs:attribute>
33 </xs:restriction>
34 </xs:simpleContent>
35 </xs:complexType>
36 <xs:complexType name="AcknowledgementMessageText.CT">
37     <xs:simpleContent>
38         <xs:restriction base="cct:Text.CT">
39             <xs:maxLength value="210"/>
40         </xs:restriction>
41     </xs:simpleContent>
42 </xs:complexType>
43 <xs:annotation>
44     <xs:documentation>Document root elements</xs:documentation>
45 </xs:annotation>
46 <xs:element name="ImportLicence" type="ImportLicenceDetails.CT"/>
47 <xs:element name="ExportLicence" type="ExportLicenceDetails.CT"/>
48 <xs:element name="Acknowledgement" type="AcknowledgementDetails.CT"/>
49 </xs:schema>
```

50
51

52

1.8 Potentially Reusable Data Elements

The last step the business analyst should do is to identify from the project-defined schemas those data elements that have potential for reuse in other projects and submit these data elements for concerted alignment. As an example, the following data elements (BIEs) may be proposed for concerted alignment and creation of new Common Schemas in the Central Registry.

<i>UID</i>	<i>Dictionary Entry Name</i>	<i>BIE Type</i>	<i>Object Class Term</i>	<i>Property Term</i>	<i>Representation Term</i>	<i>Business Terms</i>
IEPP00001	Licence Issuing Information. Details	ABIE	Licence Issuing Information	Details		
IEPP00002	Licence Issuing Information. Date	BBIE	Licence Issuing Information	Date	Date	
IEPP00003	Licence Issuing Information. Licence. Identifier	BBIE	Licence Issuing Information	Licence Identifier	Identifier	Licence Number
IEPP00081	Licence Issuing Information. Issuing Authority Signature. External	ASBIE	Licence Issuing Information	Issuing Authority Signature	External	
IEPP00007	Foreign Physical Address. Details	ABIE	Foreign Physical Address	Details	-	
IEPP00008	Foreign Physical Address. Street. Text	BBIE	Foreign Physical Address	Street	Text	
IEPP00009	Foreign Physical Address. City. Name	BBIE	Foreign Physical Address	City	Name	
IEPP00010	Foreign Physical Address. Country	ASBIE	Foreign Physical Address	Country	Country	
IEPP00021	Hong Kong Party. Details	ABIE	Hong Kong Party	Details	-	
IEPP00022	Hong Kong Party. Name	BBIE	Hong Kong Party	Name	Name	
IEPP00023	Hong Kong Party. Address. HK Physical Address	ASBIE	Hong Kong Party	Address	HK Physical Address	
IEPP00024	Hong Kong Party. Identifier	BBIE	Hong Kong Party	Identifier	Identifier	BR Number, HKID Number
IEPP00025	Hong Kong Party. Telephone Number. Text	BBIE	Hong Kong Party	Telephone Number	Text	
IEPP00026	Foreign Party. Details	ABIE	Foreign Party	Details		
IEPP00027	Foreign Party. Name	BBIE	Foreign Party	Name	Name	
IEPP00028	Foreign Party. Address. Foreign Physical Address	ASBIE	Foreign Party	Address	Foreign Physical Address	
IEPP00073	Error. Details	ABIE	Error	Details	-	
IEPP00074	Error. Type. Code	BBIE	Error	Type	Code	
IEPP00075	Error. Message. Text	BBIE	Error	Message	Text	
IEPP00076	Acknowledgement. Details	ABIE	Acknowledgement	Details	-	
IEPP00077	Acknowledgement. Type. Code	BBIE	Acknowledgement	Type	Code	
IEPP00078	Acknowledgement. Message. Text	BBIE	Acknowledgement	Message	Text	
IEPP00079	Acknowledgement. Error	ASBIE	Acknowledgement	Error	Error	

6

1 These data elements should be carefully specified when they are submitted for concerted alignment.
2 One possible form for specifying them is to use the modelling worksheets provided in the Design
3 Guide. As an example, the modelling worksheets that specify `Foreign Physical Address`
4 (`IEPP00007`) are illustrated as follows.

5 Alternatively, a functionally equivalent spreadsheet may be used to specify these data elements for
6 submission for concerted alignment. The Common Schema spreadsheet available in the Central
7 Registry may serve as a basis for the business analyst to prepare his own spreadsheet for specifying
8 these data elements.

9

Table IX: Aggregate Business Information Entity worksheet

AGGREGATE BUSINESS INFORMATION ENTITY WORKSHEET

A. Worksheet Information	
Worksheet ID: ABIEWS-FOREIGN PHYSICAL ADDRESS	Project ID: XMLGL
Technical Contact: Josia Chan / CECID	Administrative Contact: Thomas Lee / CECID

B. Dictionary Entry Information	
UID: IEPP00007	
Dictionary Entry Name: Foreign Physical Address. Details	Version: 1.0
Definition: Address of a location outside Hong Kong where an organization or an individual can be located	
Business Terms:	
Usage Rules:	

PART I – BUSINESS INFORMATION MODELLING

C. Reused Common Schema / Referenced Schemas and Standards	
Reused Common Schema:	
Referenced Schemas and Standards:	

D. Object Class	
Object Class Term: ForeignPhysicalAddress	

E. Aggregated BIEs					
<i>Sequence Order or "Choice"</i>	<i>UID</i>	<i>Dictionary Entry Name of Aggregated BIE</i>	<i>Dictionary Entry Name of the Representation ABIE or "External" (for ASBIE only)</i>	<i>Property Term</i>	<i>Cardinality</i>
1	IEPP00008	Foreign Physical Address. Street. Text		Street	1
2	IEPP00009	Foreign Physical Address. City. Name		City	1
3	IEPP00010	Foreign Physical Address. Country	Country. Details	Country	1

F. Business Context	
<i>Context Category</i>	<i>Values</i>
Business Process Classification	Import/Export Licencing
Service / Product Classification	In all contexts
Industry Classification	In all contexts
Geopolitical	In all contexts
Official Constraints	Import and Export Ordinance, Chapter 60 of the Laws of Hong Kong

1 **PART II – XML SCHEMA DEFINITION**

2

G. Naming**Complex Type Name:** ForeignPhysicalAddressDetails.CT

3

H. Child Elements

<i>Order</i>	<i>Element Name or xs:any</i>	<i>Element Type or Element Reference or xs:any</i>	<i>minOccurs</i>	<i>maxOccurs</i>
1	Street	ForeignPhysicalAddressStreetText.CT	1	1
2	City	ForeignPhysicalAddressCityName.CT	1	1
3	Country	CountryDetails.CT	1	1

4

I. XML Schema Code

```
<xs:complexType name="ForeignPhysicalAddressDetails.CT">
  <xs:sequence>
    <xs:element name="Street" type="ForeignPhysicalAddressStreetText.CT"/>
    <xs:element name="City" type="ForeignPhysicalAddressCityName.CT"/>
    <xs:element name="Country" type="CountryDetails.CT"/>
  </xs:sequence>
</xs:complexType>
```

5

6

7

BASIC BUSINESS INFORMATION ENTITY WORKSHEET

A. Worksheet Information	
Worksheet ID: BBIEWS-FOREIGN PHYSICAL ADDRESS-STREET	Project ID: XMLGL
Technical Contact: Josia Chan / CECID	Administrative Contact: Thomas Lee / CECID

B. Dictionary Entry Information	
UID: IEPP0008	
Dictionary Entry Name: Foreign Physical Address. Street. Text	Version: 1.0
Definition: Room number, building name, street name and number, etc. in a foreign physical address	
Business Terms:	
Usage Rules:	

PART I – BUSINESS INFORMATION MODELLING

C. Reused Common Schema / Referenced Schemas and Standards	
Reused Common Schema:	
Referenced Schemas and Standards:	

D. Object Class	
Object Class Term: Foreign Physical Address	

E. Property	
Property Term: Street	

F. Representation		
Core Component Type: Text		UID: CCT00022
Representation Term: Text		Primitive Data Type: String
F1. Format Restrictions		
<i>Restriction</i>	<i>Value</i>	
Expression		
Length		
Minimum Length		
Maximum Length	210	
Enumeration		
Total Digits		
Fractional Digits		
Minimum Inclusive		
Maximum Inclusive		
Minimum Exclusive		
Maximum Exclusive		
F2. Supplementary Components		
<i>Supplementary Component</i>	<i>Default Value</i>	<i>Other Possible Values</i>

1

G. Business Context	
<i>Context Category</i>	<i>Values</i>
Business Process Classification	Import/Export Licencing
Service / Product Classification	In all contexts
Industry Classification	In all contexts
Geopolitical	In all contexts
Official Constraints	Import and Export Ordinance, Chapter 60 of the Laws of Hong Kong

2

3

PART II – XML SCHEMA DEFINITION

4

H. Complex Type
Complex Type Name: ForeignPhysicalAddressStreetText.CT

5

I. Facet of Simple Content	
<i>Facet</i>	<i>Value</i>
pattern	
length	
minLength	
maxLength	210
enumeration	
totalDigits	
fractionDigits	
minInclusive	
maxInclusive	
minExclusive	
maxExclusive	

6

J. Enumerated Attribute Values		
<i>Attribute</i>	<i>Default Value</i>	<i>Enumerated Values (Including Default Value)</i>

7

K. XML Schema Code
<pre> <xs:complexType name="ForeignPhysicalAddressStreetText.CT"> <xs:simpleContent> <xs:restriction base="cct:Text.CT"> <xs:maxLength value="210"/> </xs:restriction> </xs:simpleContent> </xs:complexType> </pre>

8

9

BASIC BUSINESS INFORMATION ENTITY WORKSHEET

A. Worksheet Information	
Worksheet ID: BBIEWS-FOREIGN PHYSICAL ADDRESS- CITY	Project ID: XMLGL
Technical Contact: Josia Chan / CECID	Administrative Contact: Thomas Lee / CECID

B. Dictionary Entry Information	
UID: IEPP0009	
Dictionary Entry Name: Foreign Physical Address. City. Name	Version: 1.0
Definition: City name in a foreign physical address	
Business Terms:	
Usage Rules:	

PART I – BUSINESS INFORMATION MODELLING

C. Reused Common Schema / Referenced Schemas and Standards	
Reused Common Schema:	
Referenced Schemas and Standards:	

D. Object Class	
Object Class Term: Foreign Physical Address	

E. Property	
Property Term: City	

F. Representation	
Core Component Type: Text	UID: CCT00021
Representation Term: Name	Primitive Data Type: String

F1. Format Restrictions	
<i>Restriction</i>	<i>Value</i>
Expression	
Length	
Minimum Length	
Maximum Length	35
Enumeration	
Total Digits	
Fractional Digits	
Minimum Inclusive	
Maximum Inclusive	
Minimum Exclusive	
Maximum Exclusive	

F2. Supplementary Components		
<i>Supplementary Component</i>	<i>Default Value</i>	<i>Other Possible Values</i>

1

G. Business Context	
<i>Context Category</i>	<i>Values</i>
Business Process Classification	Import/Export Licencing
Service / Product Classification	In all contexts
Industry Classification	In all contexts
Geopolitical	In all contexts
Official Constraints	Import and Export Ordinance, Chapter 60 of the Laws of Hong Kong

2

3

PART II – XML SCHEMA DEFINITION

4

H. Complex Type
Complex Type Name: ForeignPhysicalAddressCityName.CT

5

I. Facet of Simple Content	
<i>Facet</i>	<i>Value</i>
pattern	
length	
minLength	
maxLength	35
enumeration	
totalDigits	
fractionDigits	
minInclusive	
maxInclusive	
minExclusive	
maxExclusive	

6

J. Enumerated Attribute Values		
<i>Attribute</i>	<i>Default Value</i>	<i>Enumerated Values (Including Default Value)</i>

7

K. XML Schema Code
<pre><xs:complexType name="ForeignPhysicalAddressCityName.CT"> <xs:simpleContent> <xs:restriction base="cct:Name.CT"> <xs:maxLength value="35"/> </xs:restriction> </xs:simpleContent> </xs:complexType></pre>

8

9

ASSOCIATION BUSINESS INFORMATION ENTITY WORKSHEET

A. Worksheet Information	
Worksheet ID: ASBIEWS-	Project ID: XMLGL
Technical Contact: Josia Chan / CECID	Administrative Contact: Thomas Lee / CECID

B. Dictionary Entry Information	
UID: IEPP00010	
Dictionary Entry Name: Foreign Physical Address. Country	Version: 1.0
Definition: Country identification in a foreign physical address	
Business Terms:	
Usage Rules:	

PART I – BUSINESS INFORMATION MODELLING

C. Reused Common Schema	
Reused Common Schema: Country. Details	

D. Object Class	
Object Class Term: Foreign Physical Address	

E. Property	
Property Term: Country	

F. Representation	
Representation Term (Object Class Term of Representation ABIE): Country	
UID / Dictionary Entry Name of the Representation ABIE: IEPP00004 / Country. Details	

PART II – XML SCHEMA DEFINITION

G. Child Element (Complex Type Name or Element Reference or xs: any)		
Element Name: Country	Type: CountryDetails.CT	
Element Reference:		
xs: any	namespace:	processContent:

Note: this worksheet need not specify the XML Schema code. The XML Schema code should be specified in the aggregating ABIE's worksheet.

Appendix 2 Recommended List of Core Component Types

2.1 Core Component Types and Corresponding Supplementary Components

The Core Component Types are derived based on the Core Components Technical Specification (CCTS). The Copyright Statement of the CCTS is as follows :

Copyright © UN/CEFACT 2003. All Rights Reserved.

This document and translations of it may be copied and furnished to others, and derivative works that comment on or otherwise explain it or assist in its implementation may be prepared, copied, published and distributed, in whole or in part, without restriction of any kind, provided that the above copyright notice and this paragraph are included on all such copies and derivative works. However, this document itself may not be modified in any way, such as by removing the copyright notice or references to UN/CEFACT except as required to translate it into languages other than English.

<i>Core Component Type Name</i>	<i>Definition</i>	<i>Supplementary Components</i>	<i>Mandatory/Optional</i>	<i>Definition</i>
Amount	A number of monetary units specified in a currency where the unit of currency is explicit or implied.	Currency Code	Mandatory	A 3-letter alphabetic currency code in the UN/ECE Rec. 9 code list.
		Code List Version	Optional	The version of the UN/ECE Rec. 9 code list.
Binary Object	A set of finite-length sequences of binary octets.	Character Set Code	Optional	The character set of the binary object if the mime type is text. Reference IETF RFC 2045, 2046, 2047.
		Encoding Code	Optional	The decoding algorithm of the binary object. Reference IETF RFC 2045, 2046, 2047.
		Filename	Optional	The filename of the encoded binary object. Reference IETF RFC 2045, 2046, 2047
		Format	Optional	The format of the binary content..
		Mime Code	Optional	The mime type of the binary object. Reference IETF RFC 2045, 2046, 2047.
		Object URI	Optional	The Uniform Resource Identifier that identifies where the binary object is located.

<i>Core Component Type Name</i>	<i>Definition</i>	<i>Supplementary Components</i>	<i>Mandatory/Optional</i>	<i>Definition</i>
Code	A character string (letters, figures or symbols) that for brevity and/or language independence may be used to represent or replace a definitive value or text of an attribute.	Agency ID	Optional	The identification of the agency that maintains the code list.
		Agency Name	Optional	The name of the agency that maintains the code list.
		Code List ID	Optional	The identification of the code list, e.g. the URL of a source that publishes the code list.
		Code List Name	Optional	The name of the code list.
		Code List Version	Optional	The version of the code list.
		Code Name	Optional	The textual equivalent of the code content.
Date Time	A particular point in the progression of time.			
Identifier	A character string to uniquely identify and distinguish one instance of an object in an identification scheme from all other objects in the same scheme.	Agency ID	Optional	The identification of the agency that maintains the identification scheme.
		Agency Name	Optional	The name of the agency that maintains the identification scheme
		Scheme ID	Optional	The identification of the identification scheme, e.g. the URL of a source that publishes the identification scheme.
		Scheme Name	Optional	The name of the identification scheme.
		Scheme Version	Optional	The version of the identification scheme.
Indicator	A list of two mutually exclusive Boolean values that express the only possible states of a Property.			
Measure	A numeric value determined by measuring an object along with the specified unit of measure.	Code List Version	Optional	The version of the UN/ECE Rec. 20 measure unit code list.
		Unit Code	Mandatory	The unit code as defined in UN/ECE Rec. 20.
Numeric	Numeric information that is assigned or is determined by calculation, counting, or sequencing. It does not require a unit of quantity or unit of measure.			
Quantity	A number of non-monetary units possibly including fractions.	Agency ID	Optional	The identification of the agency that maintains the quantity unit code list.
		Agency Name	Optional	The name of the agency which maintains the quantity unit code list
		Code List ID	Optional	The identification of the quantity code list, e.g. the URL of a source that publishes the code list.

<i>Core Component Type Name</i>	<i>Definition</i>	<i>Supplementary Components</i>	<i>Mandatory/Optional</i>	<i>Definition</i>
		Code List Version	Optional	The version of the quantity code list.
		Unit Code	Optional	The quantity unit code.
Text	A character string (i.e. a finite set of characters) generally in the form of words of a language.	Language Code	Optional	The code of the language used in the corresponding text as defined in ISO 639.
Electronic Address	An address for electronic communication, such as email address, URL.	Protocol Code	Optional	The code that specifies the communication protocol used. Reference Official IANA Registry of URI Schemes.

1

2.2 Permissible Representation Terms of Core Component Types

<i>Core Component Type Name</i>	<i>Permissible Representation Term</i>	<i>Primitive Data Type of Content Component</i>
Amount	Amount	Decimal
Binary Object	Binary Object	Binary
	Graphics	
	Picture	
	Sound	
	Video	
Code	Code	String
Date Time	Date	Date
	Date Time	Date Time
	Time	Time
Identifier	Identifier	String
Indicator	Indicator	String
	Boolean	Boolean
Measure	Measure	Decimal
Numeric	Numeric	Decimal
	Percent	
	Rate	
	Value	
Quantity	Quantity	Decimal
	Count	Integer
Text	Name	String
	Text	
Electronic Address	Electronic Address	String
	URI	URI

2

3

2.3 Format Restrictions for Different Primitive Data Types of Content Components.

4

<i>Format Restriction</i>	<i>Definition</i>	<i>Primitive Data Types</i>	<i>Remarks</i>
Expression	The restricted combination of characters to represent the string value.	<ul style="list-style-type: none"> String 	A textual description or a regular expression can be used to specify this format restriction.

<i>Format Restriction</i>	<i>Definition</i>	<i>Primitive Data Types</i>	<i>Remarks</i>
Length	The required length of the string.	<ul style="list-style-type: none"> String 	This format restriction shall not be used in combination with the Minimum Length and Maximum Length Format restrictions.
Minimum Length	The minimum length of the string.	<ul style="list-style-type: none"> String 	This format restriction shall not be used in combination with the Length Format restriction.
Maximum Length	The maximum length of the string.	<ul style="list-style-type: none"> String 	This format restriction shall not be used in combination with the Length Format restriction.
Enumeration	The exhaustive list of the allowed values of the string or the URI.	<ul style="list-style-type: none"> String URI 	
Total Digits	The maximum number of digits to be used in the numeric value.	<ul style="list-style-type: none"> Decimal Integer 	
Fractional Digits	The maximum number of fractional digits to be used in the decimal value.	<ul style="list-style-type: none"> Decimal 	
Minimum Inclusive	The lower limit of the range of the allowed values of the numeric value, date time, or duration. The lower limit is also an allowed value.	<ul style="list-style-type: none"> Date Time Date Time Decimal Integer 	This format restriction shall not be used in combination with the Minimum Exclusive format restriction.
Maximum Inclusive	The upper limit of the range of the allowed values of the numeric value, date time, or duration. The upper limit is also an allowed value.	<ul style="list-style-type: none"> Date Time Date Time Decimal Integer 	This format restriction shall not be used in combination with the Maximum Exclusive format restriction.
Minimum Exclusive	The lower limit of the range of the allowed values of the numeric value, date time, or duration. The lower limit is not an allowed value.	<ul style="list-style-type: none"> Date Time Date Time Decimal Integer 	This format restriction shall not be used in combination with the Minimum Inclusive format restriction.
Maximum Exclusive	The upper limit of the range of the allowed values of the numeric value, date time, or duration. The upper limit is not an allowed value.	<ul style="list-style-type: none"> Date Time Date Time Decimal Integer 	This format restriction shall not be used in combination with the Maximum Inclusive format restriction.

1
2

Appendix 3 Core Component Type Worksheet

CORE COMPONENT TYPE WORKSHEET³

A. Worksheet Information	
Worksheet ID: CCTWS-AMOUNT	Project ID: XMLGL
Technical Contact: Josia Chan / CECID	Administrative Contact: Thomas Lee / CECID

B. Dictionary Entry Information	
Dictionary Entry UID: CCT000001	
Dictionary Entry Name: Amount. Type	Version: 1.0
Definition: A number of monetary units specified in a currency where the unit of currency is explicit or implied.	
Business Terms: N/A	
Usage Rules: Nil	

PART I – BUSINESS INFORMATION MODELLING

C. Representation		
Type Name: Amount		
<i>Representation Term</i>	<i>Primitive Data Type of Content Component</i>	<i>Definition</i>
Amount	Decimal	A number of monetary units.

D. Supplementary Components		
<i>Supplementary Component Name</i>	<i>Definition</i>	<i>Mandatory/Optional</i>
Currency Code	A 3-letter alphabetic currency code in the code list of the UN/ECE Rec. 9.	Mandatory
Code List Version	The version of the UN/ECE Rec. 9 code list.	Optional

³ The Core Components defined in these worksheets are primarily adapted from the Core Components Technical Specification (CCTS). The Copyright Statement of the CCTS is as follows :

Copyright © UN/CEFACT 2003. All Rights Reserved.

This document and translations of it may be copied and furnished to others, and derivative works that comment on or otherwise explain it or assist in its implementation may be prepared, copied, published and distributed, in whole or in part, without restriction of any kind, provided that the above copyright notice and this paragraph are included on all such copies and derivative works. However, this document itself may not be modified in any way, such as by removing the copyright notice or references to UN/CEFACT except as required to translate it into languages other than English.

1 **PART II – XML SCHEMA DEFINITION**

2

E. Attributes		
<i>Attribute Name</i>	<i>Schema Primitive Datatype</i>	<i>Use (required/optional)</i>
currencyCode	token	required
codeListVersion	token	optional

3

F. XML Schema Code	
Representation Term: Amount	
Complex Type Name: Amount.CT	Schema Primitive Datatype: decimal
Code: <pre><xs:complexType name="Amount.CT"> <xs:simpleContent> <xs:extension base="xs:decimal"> <xs:attribute name="currencyCode" type="xs:token" use="required"/> <xs:attribute name="codeListVersion" type="xs:token" use="optional"/> </xs:extension> </xs:simpleContent> </xs:complexType></pre>	

4

5

CORE COMPONENT TYPE WORKSHEET

A. Worksheet Information	
Worksheet ID: CCTWS-BINARY OBJECT	Project ID: XMLGL
Technical Contact: Josia Chan / CECID	Administrative Contact: Thomas Lee / CECID

B. Dictionary Entry Information	
Dictionary Entry UID: CCT000002	
Dictionary Entry Name: BinaryObject. Type	Version: 1.0
Definition: A set of finite-length sequences of binary octets.	
Business Terms: N/A	
Usage Rules: Nil	

PART I – BUSINESS INFORMATION MODELLING

C. Representation		
Type Name: BinaryObject		
<i>Representation Term</i>	<i>Primitive Data Type of Content Component</i>	<i>Definition</i>
Binary Object	Binary	A set of finite-length sequences of binary octets.
Graphics	Binary	Graphics in binary octets (i.e., diagram, graphs, mathematical curves or similar representations)
Picture	Binary	Picture in binary octets (i.e., visual representation of a person, object, or scene)
Sound	Binary	Sound in binary octets.
Video	Binary	Video in binary octets.

D. Supplementary Components		
<i>Supplementary Component Name</i>	<i>Definition</i>	<i>Mandatory/Optional</i>
Character Set Code	The character set of the binary object if the mime type is text. Reference IETF RFC 2045, 2046, 2047.	Optional
Encoding Code	The decoding algorithm of the binary object. Reference IETF RFC 2045, 2046, 2047.	Optional
Filename	The filename of the encoded binary object. Reference IETF RFC 2045, 2046, 2047.	Optional
Format	The format of the binary content.	Optional
Mime Code	The mime type of the binary object. Reference IETF RFC 2045, 2046, 2047.	Optional
Object URI	The Uniform Resource Identifier that identifies where the binary object is located.	Optional

1 **PART II – XML SCHEMA DEFINITION**

2

E. Attributes		
<i>Attribute Name</i>	<i>Schema Primitive Datatype</i>	<i>Use (required/optional)</i>
characterSetCode	token	optional
encodingCode	token	optional
filename	normalizedString	optional
format	normalizedString	optional
mimeCode	token	optional
objectUri	anyURI	optional

3

F. XML Schema Code	
Representation Term: BinaryObject	
Complex Type Name: BinaryObject.CT	Schema Primitive Datatype: Binary
Code: <pre><xs:complexType name="BinaryObject.CT"> <xs:simpleContent> <xs:extension base="xs:base64Binary"> <xs:attribute name="characterSetCode" type="xs:token" use="optional"/> <xs:attribute name="encodingCode" type="xs:token" use="optional"/> <xs:attribute name="fileName" type="xs:normalizedString" use="optional"/> <xs:attribute name="format" type="xs:normalizedString" use="optional"/> <xs:attribute name="mimeCode" type="xs:token" use="optional"/> <xs:attribute name="objectUri" type="xs:anyURI" use="optional"/> </xs:extension> </xs:simpleContent> </xs:complexType></pre>	
Representation Term: Graphics	
Complex Type Name: Graphics.CT	Schema Primitive Datatype: Binary
Code: <pre><xs:complexType name="Graphics.CT"> <xs:simpleContent> <xs:extension base="xs:base64Binary"> <xs:attribute name="characterSetCode" type="xs:token" use="optional"/> <xs:attribute name="encodingCode" type="xs:token" use="optional"/> <xs:attribute name="fileName" type="xs:normalizedString" use="optional"/> <xs:attribute name="format" type="xs:normalizedString" use="optional"/> <xs:attribute name="mimeCode" type="xs:token" use="optional"/> <xs:attribute name="objectUri" type="xs:anyURI" use="optional"/> </xs:extension> </xs:simpleContent> </xs:complexType></pre>	
Representation Term: Picture	
Complex Type Name: Picture.CT	Schema Primitive Datatype: Binary
Code: <pre><xs:complexType name="Picture.CT">> <xs:simpleContent> <xs:extension base="xs:base64Binary"> <xs:attribute name="characterSetCode" type="xs:token" use="optional"/> <xs:attribute name="encodingCode" type="xs:token" use="optional"/> <xs:attribute name="fileName" type="xs:normalizedString" use="optional"/> </xs:extension> </xs:simpleContent> </xs:complexType></pre>	

```

        <xs:attribute name="format" type="xs:normalizedString"
    use="optional"/>
        <xs:attribute name="mimeType" type="xs:token" use="optional"/>
        <xs:attribute name="objectUri" type="xs:anyURI" use="optional"/>
    </xs:extension>
</xs:simpleContent>
</xs:complexType>
    
```

Representation Term: Sound

Complex Type Name: Sound.CT

Schema Primitive Datatype: Binary

Code:

```

<xs:complexType name="Sound.CT">
    <xs:simpleContent>
        <xs:extension base="xs:base64Binary">
            <xs:attribute name="characterSetCode" type="xs:token"
    use="optional"/>
            <xs:attribute name="encodingCode" type="xs:token" use="optional"/>
            <xs:attribute name="fileName" type="xs:normalizedString"
    use="optional"/>
            <xs:attribute name="format" type="xs:normalizedString"
    use="optional"/>
            <xs:attribute name="mimeType" type="xs:token" use="optional"/>
            <xs:attribute name="objectUri" type="xs:anyURI" use="optional"/>
        </xs:extension>
    </xs:simpleContent>
</xs:complexType>
    
```

Representation Term: Video

Complex Type Name: Video.CT

Schema Primitive Datatype: Binary

Code:

```

<xs:complexType name="Video.CT">
    <xs:simpleContent>
        <xs:extension base="xs:base64Binary">
            <xs:attribute name="characterSetCode" type="xs:token"
    use="optional"/>
            <xs:attribute name="encodingCode" type="xs:token" use="optional"/>
            <xs:attribute name="fileName" type="xs:normalizedString"
    use="optional"/>
            <xs:attribute name="format" type="xs:normalizedString"
    use="optional"/>
            <xs:attribute name="mimeType" type="xs:token" use="optional"/>
            <xs:attribute name="objectUri" type="xs:anyURI" use="optional"/>
        </xs:extension>
    </xs:simpleContent>
</xs:complexType>
    
```

1
2

CORE COMPONENT TYPE WORKSHEET

A. Worksheet Information	
Worksheet ID: CCTWS-CODE	Project ID: XMLGL
Technical Contact Josia Chan / CECID	Administrative Contact: Thomas Lee / CECID

B. Dictionary Entry Information	
Dictionary Entry UID: CCT000003	
Dictionary Entry Name: Code. Type	Version: 1.0
Definition: A character string (letters, figures or symbols) that for brevity and/or language independence may be used to represent or replace a definitive value or text of an Attribute together with relevant supplementary information.	
Business Terms: N/A	
Usage Rules: Nil	

PART I – BUSINESS INFORMATION MODELLING

C. Representation		
Type Name: Code		
<i>Representation Term</i>	<i>Primitive Data Type of Content Component</i>	<i>Definition</i>
Code	String	Same as above.

D. Supplementary Components		
<i>Supplementary Component Name</i>	<i>Definition</i>	<i>Mandatory/Optional</i>
Agency ID	The identification of the agency which maintains the unit code list.	Optional
Agency Name	The name of the agency which maintains the unit code list	Optional
Code List ID	The identification of the code list, e.g. the URL of a source that publishes the code list.	Optional
Code List Name	The name of the code list.	Optional
Code List Version	The version of the code list.	Optional
Code Name	The textual equivalent of the code content.	Optional

1 **PART II – XML SCHEMA DEFINITION**

2

E. Attributes		
<i>Attribute Name</i>	<i>Schema Primitive Datatype</i>	<i>Use (required/optional)</i>
agencyId	normalizedString	optional
agencyName	normalizedString	optional
codeListId	normalizedString	optional
codeListName	normalizedString	optional
codeListVersion	token	optional
codeName	normalizedString	optional

3

F. XML Schema Code	
Representation Term: Code	
Complex Type Name: Code.CT	Schema Primitive Datatype: String
Code: <pre> <xs:complexType name="Code.CT"> <xs:simpleContent> <xs:extension base="xs:string"> <xs:attribute name="agencyId" type="xs:normalizedString" use="optional"/> <xs:attribute name="agencyName" type="xs:normalizedString" use="optional"/> <xs:attribute name="codeListId" type="xs:normalizedString" use="optional"/> <xs:attribute name="codeListName" type="xs:normalizedString" use="optional"/> <xs:attribute name="codeListVersion" type="xs:token" use="optional"/> <xs:attribute name="codeName" type="xs:normalizedString" use="optional"/> </xs:extension> </xs:simpleContent> </xs:complexType> </pre>	

4

5

CORE COMPONENT TYPE WORKSHEET

A. Worksheet Information	
Worksheet ID: CCTWS-DATETIME	Project ID: XMLGL
Technical Contact: Josia Chan / CECID	Administrative Contact: Thomas Lee / CECID

B. Dictionary Entry Information	
Dictionary Entry UID: CCT000004	
Dictionary Entry Name: DateTime. Type	Version: 1.0
Definition: A particular point in the progression of time together with relevant supplementary information.	
Business Terms: N/A	
Usage Rules: Nil	

PART I – BUSINESS INFORMATION MODELLING

C. Representation		
Type Name: DateTime		
<i>Representation Term</i>	<i>Primitive Data Type of Content Component</i>	<i>Definition</i>
Date	Date	A date with date value only.
DateTime	Date Time	A date with date and time values.
Time	Time	A date with time value only.

D. Supplementary Components		
<i>Supplementary Component Name</i>	<i>Definition</i>	<i>Mandatory/Optional</i>
Nil		

1 **PART II – XML SCHEMA DEFINITION**

2

E. Attributes		
<i>Attribute Name</i>	<i>Schema Primitive Datatype</i>	<i>Use (required/optional)</i>
Nil		

3

F. XML Schema Code	
Representation Term: Date	
Complex Type Name: Date.CT	Schema Primitive Datatype: Date
Code: <pre><xs:complexType name="Date.CT"> <xs:simpleContent> <xs:extension base="xs:date"/> </xs:simpleContent> </xs:complexType></pre>	
Representation Term: DateTime	
Complex Type Name: DateTime.CT	Schema Primitive Datatype: Date Time
Code: <pre><xs:complexType name="DateTime.CT"> <xs:simpleContent> <xs:extension base="xs:dateTime"/> </xs:simpleContent> </xs:complexType></pre>	
Representation Term: Time	
Complex Type Name: Time.CT	Schema Primitive Datatype: Time
Code: <pre><xs:complexType name="Time.CT"> <xs:simpleContent> <xs:extension base="xs:time"/> </xs:simpleContent> </xs:complexType></pre>	

4

5

CORE COMPONENT TYPE WORKSHEET

A. Worksheet Information	
Worksheet ID: CCTWS-IDENTIFIER	Project ID: XMLGL
Technical Contact: Josia Chan / CECID	Administrative Contact: Thomas Lee / CECID

B. Dictionary Entry Information	
Dictionary Entry UID: CCT000005	
Dictionary Entry Name: Identifier. Type	Version: 1.0
Definition: A character string to identify and distinguish uniquely, one instance of an object in an identification scheme from all other objects in the same scheme together with relevant supplementary information.	
Business Terms: N/A	
Usage Rules: Nil	

PART I – BUSINESS INFORMATION MODELLING

C. Representation		
Type Name: Identifier		
<i>Representation Term</i>	<i>Primitive Data Type of Content Component</i>	<i>Definition</i>
Identifier	String	Same as above.

D. Supplementary Components		
<i>Supplementary Component Name</i>	<i>Definition</i>	<i>Mandatory/Optional</i>
Agency ID	The identification of the agency that maintains the identification scheme.	Optional
Agency Name	The name of the agency that maintains the identification scheme	Optional
Scheme Id	The identification of the identification scheme, e.g. the URL of a source that publishes the identification scheme.	Optional
Scheme Name	The name of the identification scheme.	Optional
Scheme Version	The version of the identification scheme.	Optional

1 **PART II – XML SCHEMA DEFINITION**

2

E. Attributes		
<i>Attribute Name</i>	<i>Schema Primitive Datatype</i>	<i>Use (required/optional)</i>
agencyId	normalizedString	optional
agencyName	normalizedString	optional
schemeId	normalizedString	optional
schemeName	normalizedString	optional
schemeVersion	token	optional

3

F. XML Schema Code	
Representation Term: Identifier	
Complex Type Name: Identifier.CT	Schema Primitive Datatype: String
Code: <pre> <xs:complexType name="Identifier.CT"> <xs:simpleContent> <xs:extension base="xs:string"> <xs:attribute name="agencyId" type="xs:normalizedString" use="optional"/> <xs:attribute name="agencyName" type="xs:normalizedString" use="optional"/> <xs:attribute name="schemeId" type="xs:normalizedString" use="optional"/> <xs:attribute name="schemeName" type="xs:normalizedString" use="optional"/> <xs:attribute name="schemeVersion" type="xs:token" use="optional"/> </xs:extension> </xs:simpleContent> </xs:complexType> </pre>	

4

5

CORE COMPONENT TYPE WORKSHEET

A. Worksheet Information	
Worksheet ID: CCTWS-INDICATOR	Project ID: XMLGL
Technical Contact: Josia Chan / CECID	Administrative Contact: Thomas Lee / CECID

B. Dictionary Entry Information	
Dictionary Entry UID: CCT000006	
Dictionary Entry Name: Indicator. Type	Version: 1.0
Definition: A list of two mutually exclusive Boolean values that express the only possible states of a Property.	
Business Terms: N/A	
Usage Rules: Nil	

PART I – BUSINESS INFORMATION MODELLING

C. Representation		
Type Name: Indicator		
<i>Representation Term</i>	<i>Primitive Data Type of Content Component</i>	<i>Definition</i>
Indicator	String	A list of two mutually exclusive Boolean values expressed as string.
Boolean	Boolean	Binary-valued logic of true or false.

D. Supplementary Components		
<i>Supplementary Component Name</i>	<i>Definition</i>	<i>Mandatory/Optional</i>
Nil		

1 **PART II – XML SCHEMA DEFINITION**

2

E. Attributes		
<i>Attribute Name</i>	<i>Schema Primitive Datatype</i>	<i>Use (required/optional)</i>
Nil		

3

F. XML Schema Code	
Representation Term: Indicator	
Complex Type Name: Indicator.CT	Schema Primitive Datatype: String
Code: <pre><xs:complexType name="Indicator.CT"> <xs:simpleContent> <xs:extension base="xs:string"/> </xs:simpleContent> </xs:complexType></pre>	
Representation Term: Boolean	
Complex Type Name: Boolean.CT	Schema Primitive Datatype: Boolean
Code: <pre><xs:complexType name="Boolean.CT"> <xs:simpleContent> <xs:extension base="xs:boolean"/> </xs:simpleContent> </xs:complexType></pre>	

4

5

1
2
3
4
5
6
7
8
9
10

CORE COMPONENT TYPE WORKSHEET

A. Worksheet Information	
Worksheet ID: CCTWS-MEASURE	Project ID: XMLGL
Technical Contact: Josia Chan / CECID	Administrative Contact: Thomas Lee / CECID

B. Dictionary Entry Information	
Dictionary Entry UID: CCT000007	
Dictionary Entry Name: Measure. Type	Version: 1.0
Definition: A numeric value determined by measuring an object along with the specified unit of measure.	
Business Terms: N/A	
Usage Rules: Nil	

PART I – BUSINESS INFORMATION MODELLING

C. Representation		
Type Name: Measure		
<i>Representation Term</i>	<i>Primitive Data Type of Content Component</i>	<i>Definition</i>
Measure	Decimal	Same as above.

D. Supplementary Components		
<i>Supplementary Component Name</i>	<i>Definition</i>	<i>Mandatory/Optional</i>
Code List Version	The version of the UN/EXE Rec. 20 measure unit code list.	Optional
Unit Code	The unit code as defined in the UN/ECE Rec. 20.	Mandatory

1 **PART II – XML SCHEMA DEFINITION**

2

E. Attributes		
<i>Attribute Name</i>	<i>Schema Primitive Datatype</i>	<i>Use (required/optional)</i>
codeListVersion	token	optional
unitCode	token	required

3

F. XML Schema Code	
Representation Term: Measure	
Complex Type Name: Measure.CT	Schema Primitive Datatype: decimal
Code: <pre><xs:complexType name="Measure.CT"> <xs:simpleContent> <xs:extension base="xs:decimal"> <xs:attribute name="codeListVersion" type="xs:token" use="optional"/> <xs:attribute name="unitCode" type="xs:token" use="required"/> </xs:extension> </xs:simpleContent> </xs:complexType></pre>	

4

5

CORE COMPONENT TYPE WORKSHEET

A. Worksheet Information	
Worksheet ID: CCTWS-NUMERIC	Project ID: XMLGL
Technical Contact: Josia Chan / CECID	Administrative Contact: Thomas Lee / CECID

B. Dictionary Entry Information	
Dictionary Entry UID: CCT000008	
Dictionary Entry Name: Numeric. Type	Version: 1.0
Definition: Numeric information that is assigned or is determined by calculation, counting, or sequencing. It does not require a unit of quantity or unit of measure.	
Business Terms: N/A	
Usage Rules: Nil	

PART I – BUSINESS INFORMATION MODELLING

C. Representation		
Type Name: Numeric		
<i>Representation Term</i>	<i>Primitive Data Type of Content Component</i>	<i>Definition</i>
Numeric	Decimal	A piece of numeric information.
Percent	Decimal	Percentage.
Rate	Decimal	Rate.
Value	Decimal	Value.

D. Supplementary Components		
<i>Supplementary Component Name</i>	<i>Definition</i>	<i>Mandatory/Optional</i>
Nil		

1 **PART II – XML SCHEMA DEFINITION**

2

E. Attributes		
<i>Attribute Name</i>	<i>Schema Primitive Datatype</i>	<i>Use (required/optional)</i>
Nil		

3

F. XML Schema Code	
Representation Term: Numeric	
Complex Type Name: Numeric.CT	Schema Primitive Datatype: Decimal
Code: <pre><xs:complexType name="Numeric.CT"> <xs:simpleContent> <xs:extension base="xs:decimal"/> </xs:simpleContent> </xs:complexType></pre>	
Representation Term: Percent	
Complex Type Name: Percent.CT	Schema Primitive Datatype: Decimal
Code: <pre><xs:simpleContent name="Percent.CT"> <xs:extension base="xs:decimal"/> </xs:simpleContent></pre>	
Representation Term: Rate	
Complex Type Name: Rate.CT	Schema Primitive Datatype: Decimal
Code: <pre><xs:complexType name="Rate.CT"> <xs:simpleContent> <xs:extension base="xs:decimal"/> </xs:simpleContent> </xs:complexType></pre>	
Representation Term: Value	
Complex Type Name: Value.CT	Schema Primitive Datatype: Decimal
Code: <pre><xs:complexType name="Value.CT"> <xs:simpleContent> <xs:extension base="xs:decimal"/> </xs:simpleContent> </xs:complexType></pre>	

4

5

CORE COMPONENT TYPE WORKSHEET

A. Worksheet Information	
Worksheet ID: CCTWS-QUANTITY	Project ID: XMLGL
Technical Contact: Josia Chan / CECID	Administrative Contact: Thomas Lee / CECID

B. Dictionary Entry Information	
Dictionary Entry UID: CCT000009	
Dictionary Entry Name: Quantity. Type	Version: 1.0
Definition: A number of non-monetary units possibly including fractions.	
Business Terms: N/A	
Usage Rules: Nil	

PART I – BUSINESS INFORMATION MODELLING

C. Representation		
Type Name: Quantity		
<i>Representation Term</i>	<i>Primitive Data Type of Content Component</i>	<i>Definition</i>
Quantity	Decimal	A quantity possibly including fractions.
Count	Integer	An integral count.

D. Supplementary Components		
<i>Supplementary Component Name</i>	<i>Definition</i>	<i>Mandatory/Optional</i>
Agency ID	The identification of the agency which maintains the quantity unit code list.	Optional
Agency Name	The name of the agency which maintains the quantity unit code list	Optional
Code List ID	The identification of the quantity code list, e.g. the URL of a source that publishes the code list.	Optional
Code List Version	The version of the quantity code list.	Optional
Unit Code	The quantity unit code.	Optional

1 **PART II – XML SCHEMA DEFINITION**

2

E. Attributes		
<i>Attribute Name</i>	<i>Schema Primitive Datatype</i>	<i>Use (required/optional)</i>
agencyId	normalizedString	optional
agencyName	normalizedString	optional
codeListId	normalizedString	optional
codeListVersion	token	optional
unitCode	token	optional

3

F. XML Schema Code	
Representation Term: Quantity	
Complex Type Name: Quantity.CT	Schema Primitive Datatype: Decimal
Code:	
<pre><xs:complexType name="Quantity.CT"> <xs:simpleContent> <xs:extension base="xs:decimal"> <xs:attribute name="agencyId" type="xs:normalizedString" use="optional"/> <xs:attribute name="agencyName" type="xs:normalizedString" use="optional"/> <xs:attribute name="codeListId" type="xs:normalizedString" use="optional"/> <xs:attribute name="codeListVersion" type="xs:token" use="optional"/> <xs:attribute name="unitCode" type="xs:token" use="optional"/> </xs:extension> </xs:simpleContent> </xs:complexType></pre>	
Representation Term: Count	
Complex Type Name: Count.CT	Schema Primitive Datatype: Integer
Code:	
<pre><xs:complexType name="Count.CT"> <xs:simpleContent> <xs:extension base="xs:integer"> <xs:attribute name="agencyId" type="xs:normalizedString" use="optional"/> <xs:attribute name="agencyName" type="xs:normalizedString" use="optional"/> <xs:attribute name="codeListId" type="xs:normalizedString" use="optional"/> <xs:attribute name="codeListVersion" type="xs:token" use="optional"/> <xs:attribute name="unitCode" type="xs:token" use="optional"/> </xs:extension> </xs:simpleContent> </xs:complexType></pre>	

4

5

CORE COMPONENT TYPE WORKSHEET

A. Worksheet Information	
Worksheet ID: CCTWS-TEXT	Project ID: XMLGL
Technical Contact: Josia Chan / CECID	Administrative Contact: Thomas Lee / CECID

B. Dictionary Entry Information	
Dictionary Entry UID: CCT000010	
Dictionary Entry Name: Text. Type	Version: 1.0
Definition: A character string (i.e. a finite set of characters) generally in the form of words of a language.	
Business Terms: N/A	
Usage Rules: Nil	

PART I – BUSINESS INFORMATION MODELLING

C. Representation		
Type Name: Text		
<i>Representation Term</i>	<i>Primitive Data Type of Content Component</i>	<i>Definition</i>
Name	String	A name.
Text	String	A piece of textual information.

D. Supplementary Components		
<i>Supplementary Component Name</i>	<i>Definition</i>	<i>Mandatory/Optional</i>
Language Code	The code of the language used in the corresponding text.	Optional

1 **PART II – XML SCHEMA DEFINITION**

2

E. Attributes		
<i>Attribute Name</i>	<i>Schema Primitive Datatype</i>	<i>Use (required/optional)</i>
language Code	language	optional

3

F. XML Schema Code	
Representation Term: Text	
Complex Type Name: Text.CT	Schema Primitive Datatype: String
Code: <pre><xs:complexType name="Text.CT"> <xs:simpleContent> <xs:extension base="xs:string"> <xs:attribute name="languageCode" type="xs:language" use="optional"/> </xs:extension> </xs:simpleContent> </xs:complexType></pre>	
Representation Term: Name	
Complex Type Name: Name.CT	Schema Primitive Datatype: String
Code: <pre><xs:complexType name="Name.CT"> <xs:simpleContent> <xs:extension base="xs:string"> <xs:attribute name="languageCode" type="xs:language" use="optional"/> </xs:extension> </xs:simpleContent> </xs:complexType></pre>	

4

5

CORE COMPONENT TYPE WORKSHEET

A. Worksheet Information	
Worksheet ID: CCTWS-ELECTRONIC ADDRESS	Project ID: XMLGL
Technical Contact: Josia Chan / CECID	Administrative Contact: Thomas Lee / CECID

B. Dictionary Entry Information	
Dictionary Entry UID: CCT000011	
Dictionary Entry Name: ElectronicAddress. Type	Version: 1.0
Definition: An address for electronic communication.	
Business Terms: N/A	
Usage Rules: Nil	

PART I – BUSINESS INFORMATION MODELLING

C. Representation		
Type Name: ElectronicAddress		
<i>Representation Term</i>	<i>Primitive Data Type of Content Component</i>	<i>Definition</i>
ElectronicAddress	String	Same as above.
URI	URI	A Uniform Resource Identifier Reference.

D. Supplementary Components		
<i>Supplementary Component Name</i>	<i>Definition</i>	<i>Mandatory/Optional</i>
Protocol Code	The code that specifies the communication protocol used. Reference Official IANA Registry of URI Schemes.	Optional

1 **PART II – XML SCHEMA DEFINITION**

2

E. Attributes		
<i>Attribute Name</i>	<i>Schema Primitive Datatype</i>	<i>Use (required/optional)</i>
protocolCode	token	optional

3

F. XML Schema Code	
Representation Term: ElectronicAddress	
Complex Type Name: ElectronicAddress.CT	Schema Primitive Datatype: String
Code: <pre><xs:complexType name="ElectronicAddress.CT"> <xs:simpleContent> <xs:extension base="xs:string"> <xs:attribute name="protocolCode" type="xs:token" use="optional"/> </xs:extension> </xs:simpleContent> </xs:complexType></pre>	
Representation Term: URI	
Complex Type Name: URI.CT	Schema Primitive Datatype: URI
Code: <pre><xs:complexType name="URI.CT"> <xs:simpleContent> <xs:extension base="xs:anyURI"> <xs:attribute name="protocolCode" type="xs:token" use="optional"/> </xs:extension> </xs:simpleContent> </xs:complexType></pre>	

Appendix 4 Sample XML Schema Design Worksheets

BUSINESS COLLABORATION WORKSHEET

A. Worksheet Information	
Worksheet ID: BCWS-	Project ID:
Technical Contact:	Administrative Contact:

B. Business Collaboration Properties
Name:
Description:
Scope:
Pre-conditions:

C. Roles	
<i>Name</i>	<i>Description</i>

D. Business Transactions	
<i>Name</i>	<i>Description</i>

E. Business Documents	
<i>Name</i>	<i>Description</i>

BUSINESS TRANSACTION WORKSHEET

1
2

A. Worksheet Information	
Worksheet ID: BTWS-	Project ID:
Technical Contact:	Administrative Contact:

3

B. Business Transaction Properties	
Name:	One/Two-Way:
Description:	
Scope:	
Pre-conditions:	
Requesting Role:	Responding Role:

4

C. Request Document Flow		
Description:		
Non-Repudiation Required:		Data Confidentiality Required:
C1. Request Documents		
<i>No.</i>	<i>Document Name</i>	<i>Business Information Carried</i>

5

D. Response Document Flow		
Description:		
Success Conditions:		
Non-Repudiation Required:		Data Confidentiality Required:
D1. Positive Response Documents		
<i>No.</i>	<i>Document Name</i>	<i>Business Information Carried</i>
D2. Negative Response Documents		
<i>No.</i>	<i>Document Name</i>	<i>Business Information Carried</i>

6
7

BUSINESS DOCUMENT WORKSHEET

1
2
3
4
5
6
7
8
9
10
11
12

A. Worksheet Information	
Worksheet ID: BDWS-	Project ID:
Technical Contact:	Administrative Contact:

B. Dictionary Entry Information	
UID:	
Dictionary Entry Name:	Version:
Definition:	
Business Terms:	
Usage Rules:	

PART I – BUSINESS INFORMATION MODELLING

C. Document Name
Document Name (Object Class Term of Root ABIE):
UID / Dictionary Entry Name of Root ABIE:

PART II – XML SCHEMA DEFINITION

D. XML Schema Code
Element Name:
Complex Type:

AGGREGATE BUSINESS INFORMATION ENTITY WORKSHEET

1
2
3
4
5
6
7
8
9
10
11

A. Worksheet Information	
Worksheet ID: ABIEWS-	Project ID:
Technical Contact:	Administrative Contact:

B. Dictionary Entry Information	
UID:	
Dictionary Entry Name:	Version:
Definition:	
Business Terms:	
Usage Rules:	

PART I – BUSINESS INFORMATION MODELLING

C. Reused Common Schema / Referenced Schemas and Standards	
Reused Common Schema:	
Referenced Schemas and Standards:	

D. Object Class	
Object Class Term:	

E. Aggregated BIEs					
<i>Sequence Order or "Choice"</i>	<i>UID</i>	<i>Dictionary Entry Name of the aggregated BIE</i>	<i>Dictionary Entry Name of the Representation ABIE or "External" (for ASBIE only)</i>	<i>Property Term</i>	<i>Cardinality</i>

F. Business Context	
<i>Context Category</i>	<i>Values</i>
Business Process Classification	
Service / Product Classification	
Industry Classification	
Geopolitical	
Official Constraints	

1 **PART II – XML SCHEMA DEFINITION**

2

G. Naming
Complex Type Name:

3

H. Child Elements				
<i>Order</i>	<i>Element Name or xs:any</i>	<i>Element Type or Element Reference or xs:any</i>	<i>minOccurs</i>	<i>maxOccurs</i>

4

I. XML Schema Code

5

6

1
2
3
4
5
6
7
8
9
10
11
12
13
14
15
16
17

ASSOCIATION BUSINESS INFORMATION ENTITY WORKSHEET

A. Worksheet Information	
Worksheet ID: ASBIEWS-	Project ID:
Technical Contact:	Administrative Contact:

B. Dictionary Entry Information	
UID:	
Dictionary Entry Name:	Version:
Definition:	
Business Terms:	
Usage Rules:	

PART I – BUSINESS INFORMATION MODELLING

C. Reused Common Schema
Reused Common Schema:

D. Object Class
Object Class Term:

E. Property
Property Term:

F. Representation
Representation Term (Object Class Term of Representation ABIE):
UID / Dictionary Entry Name of the Representation ABIE:

PART II – XML SCHEMA DEFINITION

G. Child Element (Complex Type Name or Element Reference or <i>xs: any</i>)		
Element Name:	Type:	
Element Reference:		
<i>xs: any</i>	namespace:	processContent:

Note: this worksheet need not specify the XML Schema code. The XML Schema code should be specified in the aggregating ABIE’s worksheet.

BASIC BUSINESS INFORMATION ENTITY WORKSHEET

A. Worksheet Information	
Worksheet ID: BBIEWS-	Project ID:
Technical Contact:	Administrative Contact:

B. Dictionary Entry Information	
UID:	
Dictionary Entry Name:	Version:
Definition:	
Business Terms:	
Usage Rules:	

PART I – BUSINESS INFORMATION MODELLING

C. Reused Common Schema / Referenced Schemas and Standards	
Reused Common Schema:	
Referenced Schemas and Standards:	

D. Object Class	
Object Class Term:	

E. Property	
Property Term:	

F. Representation	
Core Component Type:	UID:
Representation Term:	Primitive Data Type:

F1. Format Restrictions	
<i>Restriction</i>	<i>Value</i>
Expression	
Length	
Minimum Length	
Maximum Length	
Enumeration	
Total Digits	
Fractional Digits	
Minimum Inclusive	
Maximum Inclusive	
Minimum Exclusive	
Maximum Exclusive	

F2. Supplementary Components		
<i>Supplementary Component</i>	<i>Default Value</i>	<i>Other Possible Values</i>

1
2
3
4
5
6
7
8
9
10

G. Business Context	
<i>Context Category</i>	<i>Values</i>
Business Process Classification	
Service / Product Classification	
Industry Classification	
Geopolitical	
Official Constraints	

PART II – XML SCHEMA DEFINITION

H. Complex Type
Complex Type Name:

I. Facet of Simple Content	
<i>Facet</i>	<i>Value</i>
pattern	
length	
minLength	
maxLength	
enumeration	
totalDigits	
fractionDigits	
minInclusive	
maxInclusive	
minExclusive	
maxExclusive	

J. Enumerated Attribute Values		
<i>Attribute</i>	<i>Default Value</i>	<i>Enumerated Values (Including Default Value)</i>

K. XML Schema Code

CORE COMPONENT TYPE WORKSHEET

A. Worksheet Information	
Worksheet ID: CCTWS-	Project ID:
Technical Contact	Administrative Contact:

B. Dictionary Entry Information	
UID:	
Dictionary Entry Name:	Version:
Definition:	
Business Terms:	
Usage Rules:	

PART I – BUSINESS INFORMATION MODELLING

C. Representation		
Type Name:		
<i>Representation Term</i>	<i>Primitive Data Type of Content Component</i>	<i>Definition</i>

D. Supplementary Components		
<i>Supplementary Component Name</i>	<i>Definition</i>	<i>Mandatory/Optional</i>

PART II – XML SCHEMA DEFINITION

E. Attributes		
<i>Attribute Name</i>	<i>Schema Primitive Datatype</i>	<i>Use (required/optional)</i>

F. XML Schema Code	
Representation Term:	
Complex Type Name:	Schema Primitive Datatype:
Code :	
Representation Term:	
Complex Type Name:	Schema Primitive Datatype:
Code :	

Appendix 5 Implementing eBusiness Solutions

5.1 Introduction

In general, to facilitate business partners to collaborate with each other, there are several aspects they need to agree upon. Usually they go through some negotiations with each other and come up with an agreed profile for each party. Each agreed profile consists of a bundle of agreements in all aspects of the collaboration. After that, the business partners can start to implement their solutions according to the agreed profile. Interoperability can be guaranteed if all the implementations conform to the agreed profile.

Within those aspects to be agreed by the business partners, document schema is one of the most important ones. Other issues include agreement on document flow sequence and the related aspects; agreement on messaging layer parameters, such as transport protocol and quality of service (QoS) needed; and agreement on security measures, etc.

This Appendix briefly describes those aspects upon which business partners need to agree when implementing an eBusiness solution.

5.2 Document Flow

A non-trivial e-business collaboration normally involves a sequence of document exchanges between two or more business partners. Therefore, in addition to the schemas of the documents for exchange, business partners must specify and agree upon other document exchange parameters, such as the sequence (or choreograph) and the directions of document flows, before they can conduct an e-business collaboration. Some of these typical parameters are discussed in the following sub-sections.

5.2.1. *Choreography*

Choreography describes the sequence of document exchanges between the business partners.

A simple example of document choreography is illustrated in a buying scenario. When a buyer wants to buy something from the supplier, the buyer will firstly send to the supplier a request for a quotation document. Then the supplier will send back a quotation document to the buyer. Next, the buyer will send a purchase order document to the supplier. Upon accepting this order, the supplier will send an invoice document to the buyer.

There are many ways to represent document exchange choreography. In a UML tool, this could be done using a UML activity diagram. Also, ebXML Business Process Specification Schema (ebBPSS) is an XML representation of the collaboration between business partners.

1 **5.2.2. Receipts and Acceptance Notices**

2 The immediate issue for managing document exchange choreography is the management of business
3 process state. Business process state is determined by up to which document exchange is completed in
4 the choreography. Typically, the business partners keep their own state individually in a distributed
5 way. Therefore, it is important for the business partners to exchange signals from time to time to make
6 sure that their business state is synchronous.

7 Although the transport layer may provide a reliable channel for delivering business documents
8 between business partners, application level signals (also known as business signals) are needed to
9 guarantee the complete synchronization of state. Together with the reliable messaging channel, the
10 business signals provide guarantees that the corresponding business documents have been processed
11 by the respective applications.

12 In general, business signals can be divided into two categories: receipts and acceptance notices. A
13 receipt signal tells that a business document has been properly received by the underlying messaging
14 software component. An acceptance notice signal tells that a business document has been accepted for
15 business processing by the receiving application.

16 **5.2.3. Time-Out Mechanism**

17 A business process normally has to be completed within a time limit. Therefore, the business partners
18 should agree on a time-out value for each of the business documents and business signals to be
19 exchanged. Typically, the time-out value specifies the maximum time the recipient of the business
20 document can take to process the document before it sends out the required receipts, acceptance
21 notices or responding business documents.

22 In operation, all business partners should keep their own timers. Failure to send or receive a business
23 document or business signal within a specified time-out value will result in the abortion of current
24 business process.

25 **5.2.4. Exception**

26 There may be many unexpected cases that will cause the current business process to abort. As
27 discussed above, the business partners may decide to abort the current business process in case of
28 failure of receiving a business document or a signal within a specified time. Also, internal error
29 happened in the system of a business partner can fail the current business process.

30 The mechanism for aborting the current business process should span across all business partners. This
31 is essential for all parties to be aware of the abortion and thus they can perform their own clean-up
32 mechanisms individually. Therefore, the exception mechanism should include exchanges of exception
33 messages so that all business partners can be informed when exceptions occur.

34 **5.3 Messaging**

35 Messaging involves the methods on sending and receiving business documents between business
36 partners. At the minimum level, the business partners have to agree on the basic transport method of
37 the business documents. On top of that, they can decide on the add-on services that provide different
38 quality of service (QoS). Below, various issues related to messaging, on which the business partners
39 may need to agree, are discussed.

1 **5.3.1. Transport Protocol**

2 The transport protocol is the most basic parameter the business partners have to agree on. The choice
3 of transport protocol affects the software implementation that links up the systems of the business
4 partners. There are many open transport protocols commonly used on the Internet. Most of these open
5 protocols are mature so that many ready-to-use solutions are available, both commercially and in the
6 open-source community. Three common transport protocols are discussed here.

7 Hyper-Text Transfer Protocol (HTTP) is the most commonly used protocol on the Internet. The
8 popularity of the World Wide Web makes HTTP widely accepted by most corporations. HTTP is
9 firewall-friendly and has many existing applications built on top of it. HTTP is usually used to
10 implement synchronous messaging.

11 Simple Mail Transfer Protocol (SMTP) is primarily used by email applications. It is also firewall-
12 friendly and it is particularly useful to support asynchronous applications, as SMTP is less system-
13 interactive compared with HTTP.

14 File Transfer Protocol (FTP) is well known for its simplicity to transfer a file over a network. It is still
15 the dominant protocol used for file upload and download on the Internet. Compared with HTTP, it is
16 less system-interactive and is quite limited to file transfers only.

17 **5.3.2. Reliability**

18 Most open protocols commonly used on the Internet nowadays are best-effort protocols. That means
19 the sender software will try to deliver the messages to the receiver software only once. If, for any
20 reason, the messages cannot reach the receiver software, the sender software will give up and report
21 error.

22 Reliable messaging is a technology that provides mechanism for the sender software to retry message
23 deliveries. The sender and receiver software should be implementing a common reliable messaging
24 protocol. The basic idea is simple. Upon receiving a business message, the receiver software will send
25 an acknowledgement message, corresponding to the received business message, back to the sender
26 software. This tells the sender software that the business message is received successfully. In operation,
27 the sender software will retry sending the business message several times until the acknowledgement
28 message is received.

29 Therefore, to implement reliable messaging, both business partners should co-operate to generate and
30 process acknowledgement messages. There are ready-to-use reliable messaging products available.
31 Usually, different vendors implement their own versions of reliable messaging protocols, e.g. IBM
32 MQ-Series, Microsoft Message Queue (MSMQ), etc.

33 Recently, some initiatives have tried to standardize the reliable messaging protocols, like ebXML
34 Message Service (ebMS) and Web Services Reliable Messaging (WS-RM). Theoretically, software
35 products conforming to these open standards are interoperable with each other.

36 In any case, if the business partners want to collaborate through a reliable message channel, they
37 should agree on the reliable messaging protocol to be used. With the protocol chosen, they can find a
38 suitable product individually.

39

1 **5.3.3. Duplicate Detection and Elimination**

2 If reliable messaging protocol is used, there are chances for the sender software to send the same
3 message several times. Therefore, there are chances for the receiver software to receive the same
4 message several times. In this case, duplicate detection and elimination techniques can be employed to
5 make sure that the message is processed by the application only once.

6 Usually, this can be done by adding unique keys to the messages sent. Since this issue is rooted from
7 the use of reliable messaging, all reliable messaging protocols should have addressed this issue. The
8 business partners may need to agree on whether the duplicate elimination feature in the software
9 should be turned on or not.

10 **5.3.4. Security**

11 Security on messaging is important. Exchange of business document essentially exposes business
12 information to the outside world. Obviously, the security measures should be agreed and conformed
13 by all business partners so that the information exchanged is properly protected.

14 Here, we discuss four security areas, which are common concerns when exchanging information on
15 the Internet.

16 **5.3.4.1. Confidentiality**

17 Confidentiality ensures that only the intended recipient sees the business messages, but nobody else.
18 Normally, this is done by encrypting the messages. The business partners should agree on the method
19 to be used, out of many possibilities available.

20 Briefly, encryption can be performed on two different layers: transport layer and message layer.
21 HTTPS, the secure flavour of HTTP, is an example of a transport layer encryption. The setup of
22 HTTPS server is relatively straightforward. There is no security information that the business partners
23 have to exchange beforehand.

24 PKI encryption is an example of a message layer encryption. In order to exchange messages with PKI
25 encryption, the business partners should exchange their public keys at setup time. In operation, the
26 messages exchanged are encrypted by the recipient's public key, and as a result, only the intended
27 recipient can decrypt and understand the messages.

28 **5.3.4.2. Authentication**

29 Authentication is the measure for the business partners to ensure the real identities of each other.
30 Digital signature is one way to authenticate business partners. Using PKI digital signature, the sender
31 must use its private key to sign the outgoing message so that the recipient can use the sender's public
32 key to verify the signature in the message. This way, the recipient can prove the message is actually
33 sent by the sender as claimed by the message.

34 There are some other standards that facilitate specification of authentication information. As an
35 example, OASIS⁴ Security Assertion Markup Language (SAML) is a commonly recognized standard.

⁴ Organization for the Advancement of Structured Information Standards

1 **5.3.4.3. Authorization**

2 Authorization is about what a business partner can do against the others. Usually this is specified using
3 a set of policies, and is closely related to authentication. After the recipient has authenticated the
4 sender, the recipient can decide to permit the request based on the set of policies.

5 Same as authentication, there are a number of standards that facilitate specification of authorization
6 information, e.g. eXtensible rights Markup Language (XrML) and OASIS eXtensible Access Control
7 Markup Language (XACML).

8 9 **5.3.4.4. Data Integrity**

10 It is important to make sure the messages received have not been modified by third parties. Digital
11 signature is the mainstream method to ensure message integrity. In a signed message, if the content is
12 modified by someone other than the sender during transmission, the signature verification by the
13 recipient will tell that the content is not original.

14 **5.3.5. Message Order**

15 The business partner who receives business documents may require that messages be delivered in the
16 order in which the sender has sent them out. However, there is no guarantee that the sending order can
17 always be preserved on the receiving side when messages are transmitted asynchronously over the
18 Internet. Normally this problem can be resolved by adding sequence number information to the
19 messages. In operation, the receiving software only delivers the messages with linearly-increasing
20 sequence numbers to the backend business application.

21 Like the reliable messaging, whether the message order needs to be preserved is one of the QoS
22 parameters that the business partners should agree upon before they implement their eBusiness
23 solutions.

24 **5.3.6. Auditing**

25 In some cases, the business partners may need to keep the audit trails of what messages have been
26 exchanged. The audit trails can provide non-repudiation of the sending and receiving of business
27 messages.

28 Auditing is done individually on each side of the business partners. However, the business partners
29 have to cooperate to help the others keep useful audit trails. The measures taken by the business
30 partners should be agreed beforehand. For example, the receiving software may be required to sign all
31 the acknowledgement messages digitally to ensure non-repudiation of receiving the messages.

32 **5.4 Conclusion**

33 There are open and commercial eBusiness frameworks that provide different modules to address the
34 above issues. Common frameworks include ebXML, Web Services, RosettaNet, BizTalk, etc. For
35 example, in the ebXML framework, ebXML Message Services is an open standard for messaging
36 reliability and security, and the Business Process Specification Schema (BPSS) provides a language to
37 specify business processes in terms of document exchange choreography.

1 It is recommended that open standards be followed to develop eBusiness solutions instead of
2 implementing the above mechanisms in a proprietary way. The reasons are two-fold. Firstly, the
3 eBusiness implementations based on open standards are usually more interoperable with other systems
4 than proprietary implementations. Secondly, most open standards are developed by business and
5 technical experts in different industry domains and have captured important best practices and
6 extensive deployment experiences; therefore, an open-standards-based technology can usually address
7 the requirements more completely than a proprietary technology.

8

9

Appendix 6 Intellectual Property Rights of Registry Artefacts

The Common Schemas are developed with collaborative efforts of all B/Ds and the copyright of the Common Schemas belongs to the Government of the Hong Kong Special Administrative Region (HKSARG). In order to prevent external parties from overriding the HKSARG's copyright over the Common Schemas, a copyright statement should be published on the Central Registry. Users of the Central Registry should be notified of the copyright statement before they access the content of the Central Registry.

To facilitate the use of Common Schemas, all parties should be allowed to copy and use the Common Schemas published in the Central Registry. To make this explicit, a copyright licence should be granted to all users by posting it on the Central Registry.

The copyright statement of other public schema standards like UBL have been studied before proposing the copyright statement / licence below.

With regard to the copyright of Project Schemas, project teams should agree with all project stakeholders and publish a relevant copyright statement / licence on their Project Registry.

In developing Registry Artefact by copying, adapting, modifying or otherwise using a third party copyright work, the relevant B/Ds developing the Registry Artefacts should make sure that :-

(a) Before development, an agreement should be reached with the third party copyright owner that the ownership of the copyright of both such Registry Artefact and the underlying third party copyright work would vest in the Government; or

(b) The third party copyright owner has granted the HKSARG the rights explicitly requested by the B/D developing the Registry Artefacts (such as the right to copy, modify, develop, adapt, publish, distribute, issue or make available to the public copies of or otherwise use in any other manners as intended by the users the third party copyright work concerned).

For the cases of (b) above, to allow the use of Registry Artefacts by the public, it would be more convenient if the B/D developing the Registry Artefacts can obtain the sub-licensable rights and licences from the third party copyright owner so as to allow the public to further copy, modify, develop, adapt, publish, distribute, issue or make available to others copies of or otherwise use in such other manners as may be intended by the public the Registry Artefacts which are derived from the third party copyright work. Where such sub-licensable rights and licences cannot be obtained, the B/D developing the Registry Artefact(s) should publish such derivative work(s) together with a notice saying that the Registry Artifacts is/are derived from third party copyright work(s) (such notice should also state explicitly who are the copyright owner(s) and how to contact him/them) and if the user of the Registry Artefact wishes to copy, modify, develop, adapt, publish, distribute, issue or make available to others copies of or otherwise use in any other manners such derivative work(s), the user should himself ask for the licence(s) to do so from the relevant third party copyright owner(s).

[Note : This XML Schema Design and Management Guide (this Guide) has made use of third party copyright work "Core Components Technical Specification" (CCTS) produced by the United Nations Centre for Trade Facilitation and Electronic Business (UN/CEFACT), and has made adaptation on it.

1 We have included the UN/CEFACT copyright notice and the following paragraph in relevant parts of
2 this Guide :

Copyright © UN/CEFACT 2003. All Rights Reserved.

This document and translations of it may be copied and furnished to others, and derivative works that comment on or otherwise explain it or assist in its implementation may be prepared, copied, published and distributed, in whole or in part, without restriction of any kind, provided that the above copyright notice and this paragraph are included on all such copies and derivative works. However, this document itself may not be modified in any way, such as by removing the copyright notice or references to UN/CEFACT except as required to translate it into languages other than English.

3
4 We have tried to seek from the CCTS's editing team the right to copy and adapt the CCTS in order to
5 develop this Guide, as well as the right to publish, distribute and issue this Guide, which contains
6 recommendation that originate from the CCTS. The CCTS editing team advised that we do not have to
7 do anything additional in order to copy and adapt the CCTS to develop this Guide.]

8
9 **Proposed Copyright Statement for the Central Registry (Applicable to members of the public):**

10 It is the intention of the Government of the Hong Kong Special Administrative Region (HKSARG) to
11 support and encourage the use of Common Schemas (i.e. the information model of data elements and
12 their corresponding XML schemas that have been aligned by the HKSARG). Unless otherwise
13 specified, the HKSARG owns the copyright of all the Common Schemas and any other artefacts stored
14 and published in this Central Registry (hereafter referred collectively as "Registry Artefacts"), which
15 is managed by the HKSARG.

16 Where it is specified that the user of the Registry Artefact(s) needs to make a request to any third party
17 copyright owner for the grant of a licence to copy, modify, develop, adapt, publish, distribute, issue or
18 make available to others copies of or otherwise use in such other manners as intended by the user the
19 Registry Artefact(s) in question which is/are derived from any third party copyright work(s) (Third
20 Party Work(s)), NOTHING in this Copyright Statement or the Copyright Licence hereinbelow shall be
21 taken as granting any licence in respect of the Third Party Works by the HKSARG to any users. In all
22 such cases, the users shall themselves obtain all the necessary licence(s) for all their intended uses of
23 such Registry Artefacts as derived from the Third Party Works from the relevant copyright owner(s)
24 of the Third Party Works, and unless and until that has been done, no user is permitted to make use of
25 such Registry Artefacts as derived from the Third Party Works for any purposes which may infringe
26 the copyright of any party.

27 **Proposed Copyright Licence for the Central Registry (Applicable to members of the public):**

28 **Subject to the above Copyright Statement**, the Government of the Hong Kong Special
29 Administrative Region (HKSARG) hereby grants to all users of the Central Registry a nonexclusive,
30 non-transferable and royalty-free right and licence to copy, issue to the public copies of, or make
31 adaptations (including modifications) of the Registry Artefacts (as defined in the Copyright Statement
32 for the Central Registry above).

33 The HKSARG hereby waives any claim of the copyright of any derivative works which may be
34 created by a user as a result of the modification or adaptation of any Registry Artefacts. Nevertheless,
35 the copyrights and any other intellectual property rights of such Registry Artefacts shall always remain
36 vested in the HKSARG.

1 The HKSARG expressly disclaims any and all warranties regarding the Registry Artefacts, including,
2 but not limited to, warranties of merchantability, fitness for a particular purpose, non-infringement, or
3 title; that the contents of the Registry Artefacts are suitable for any purpose; or that the implementation
4 of such Registry Artefacts will not infringe any third party patents, copyrights, trademarks or other
5 rights. These Registry Artefacts are provided on an "as is" and "with all faults" bases, and without any
6 express or implied warranty. Users are to exercise the rights and licences granted hereunder "at their
7 own risks". The HKSARG will not be liable for any direct, indirect, general, special, incidental or
8 consequential losses or damage whatsoever arising out of any uses of or inability to use the Registry
9 Artefacts or any derivative works thereof by the users or by any other parties under this Copyright
10 Licences or otherwise.

11 The HKSARG may terminate any licence hereunder at any time by posting a notice to that effect on
12 this website or by any other means which the HKSARG considers effective. Such notice, where
13 posted on the website, shall be deemed to have effect immediately at the time when it is so posted.
14 Upon such termination of licence, the user shall do all such acts as may be directed by the HKSARG
15 with respect to any copies of the Registry Artefacts in question which are in the possession or control
16 of the user.

17 For the avoidance of doubt, nothing herein shall constitute any transfer or assignment of copyrights or
18 other intellectual property rights of the Registry Artefacts to any users. All rights not specifically
19 granted herein are expressly reserved to the Government.

20 This Copyright Statement and Copyright Licence shall be governed by and construed in accordance
21 with the laws of the Hong Kong Special Administrative Region (HKSAR) and the users or any parties
22 under this Copyright Statement and Copyright Licence agree to submit to the non-exclusive
23 jurisdiction of the courts of HKSAR as regards any claim or matter arising under this Copyright
24 Statement and Copyright Licence.

Appendix 7 Glossary

- 1
- 2 **Aggregate Business Information Entity (ABIE)** – A model that represents an object class and
3 aggregates Basic and Association Business Information Entities as the properties.
- 4 **Association Business Information Entity (ASBIE)** – A model that represents a complex property in
5 an object class.
- 6 **Basic Business Information Entity (BBIE)** – A model that represents a singular property in an object
7 class.
- 8 **Business Analyst** – Project members who analyze the requirements on business process and
9 information gathered from domain experts and business users.
- 10 **Business Context** – The description of business situation which is specified through assigning values
11 to a set of Context Categories.
- 12 **Business Collaboration (BC)** – a business process in which a series of activities are conducted
13 between two or more business partners.
- 14
- 15 **Business Document** – A model that represents an electronic document for exchange; a root Aggregate
16 Business Information Entity is identified to provide the representation of the document.
- 17 **Business Information Entity (BIE)** – A piece of business data or a group of pieces of business data
18 with a unique business semantic definition.
- 19 **Business Process** – the means by which one or more activities are accomplished in operating business
20 practices.
- 21
- 22 **Business Process Modelling** – A process to model a Business Process.
- 23 **Business Process Specification Schema (BPSS)** – A specification schema in the ebXML framework
24 for specifying a Business Process in an XML document.
- 25 **Business Information Model (BIM)** – A syntactic neutral model capturing the business information
26 requirements of business information. The model can be represented in the form of Business
27 Information Entity worksheet or a spreadsheet derived from the worksheet.
- 28 **Business Information Modelling** – A process to model business information that business partners
29 exchange to transact business.
- 30 **Business Transaction (BT)** – A one-way or two-way flow of Business Documents between a
31 Requesting Role and a Responding Role.
- 32 **Candidate Common Schema** – The information model and XSD which has been created in the
33 Common Schema Management Process and is pending for review and approval.

- 1 **Central Registry** – A registry which stores all the approved Common Schemas for reference by
2 project teams.
- 3 **Common Schema** – The information model and XSD of the concertedly-aligned data elements. A
4 Common Schema is designed for reuse in different projects.
- 5 **Common Schema Creation / Change Request** – A request submitted by business analysts for
6 creating a new Common Schema or for changing a Common Schema. Business analysts can raise
7 Common Schema Creation / Change Requests if they find the proposed information model has reuse
8 potential in government joined-up projects.
- 9 **Common Schema Liaison Officers** – The body which reviews and comments candidate Common
10 Schemas. They also recommend the maturity level of Common Schemas.
- 11 **Common Schema Retirement Request** – A request to retire a Common Schema. It is raised if project
12 teams find that the Common Schema is not appropriate for reuse in new joined-up projects.
- 13 **Common Schema Task Force** – A task force formed to handle a Common Schema creation or
14 change request on a case-by-case basis.
- 15 **Context Category** – A group of one or more values used to express a characteristic of a business
16 situation.
- 17 **Core Components Technical Specification (CCTS)** – CCTS provides the approach to document the
18 information about the object class, the property, and the representation of data elements as Business
19 Information Entities.
- 20 **Core Component** – A building block for creating a semantically correct and meaningful information
21 exchange package. It contains only the information pieces necessary to describe a specific concept.
- 22 **Core Component Type (CCT)** – A model that provides the basic data structure to realize the
23 representation of a singular property in an object class.
- 24 **Data Dictionary** – A database for storing the information models that defines all relevant data
25 elements for specific use and within a specific scope. A Data Dictionary is either part of the project
26 registry for Project Schema development or part of the Central Registry for Common Schema
27 Development.
- 28 **Document Flow (DF)** – A Document Flow transmits an electronic message, which packages one or
29 more Business Documents, between the Requesting Activity and the Responding Activity.
- 30 **Electronic Business XML (ebXML)** – A set of modules that forms a complete electronic business
31 framework. Derived from the XML, ebXML is the joint initiative of United Nations body for Trade
32 Facilitation and Electronic Business Information Standards (UN/CEFACT) and the Organization for
33 the Advancement of Structured Information Standards (OASIS) to standardize the secure exchange of
34 business data.
- 35 **Extensible Markup Language (XML)** – XML is a formal recommendation from the World Wide
36 Web Consortium. It is a flexible way to create common information formats and share both the format
37 and the data on the World Wide Web, intranets, and elsewhere.
- 38 **Format Restriction** – A set of constraints on the value domain of the Content Component of a CCT
39 that provides the representation in the BBIE.

- 1 **IFCG Standing Office** – Interoperability Framework Coordination Group Standing Office is involved
2 in the operation management of Common Schemas.
- 3 **Information Model** – An information model specifies the definition, representation, etc. of a data
4 element to reflect the data element’s attributes.
- 5 **ISO 11179** – The ISO 11179 standard, specification and standardization of data elements, serves as
6 the framework for the methodology to describe data elements in a consistent way.
- 7 **Joined-up Project** – IT project which aims at joining up government services. It may involve multiple
8 Bureaus/Departments or parties outside government hierarchy.
- 9 **Maturity Level** – A scheme which defines the reusability and maturity of Common Schemas. It
10 consists of 3 possible levels: 0, 1, and 2. The higher the level number, the more mature the Common
11 Schema.
- 12 **Object class** – A set of ideas, abstractions, or things in the real world that can be identified with
13 explicit boundaries and meaning and whose properties and behaviour follow the same rules.
- 14 **Project Registry** – A Project Registry is used to store the XSDs together with the process and
15 information models for Project Schemas.
- 16 **Project Schema** – A set of related XSDs together with the information models that the project team
17 develop for a specific joined-up service project.
- 18 **Promotion** – to raise the Maturity Level of a Common Schema if the perceived reusability and
19 maturity of the schema is elevated.
- 20 **Property** – A peculiarity common to all members of an object class.
- 21 **Registry** – The Registry provides an organized way to store information. In the context of enhancing
22 data interoperability, the Registry serves to organize information models and XSDs for reference by
23 project teams.
- 24 **Representation** – A description of how the data is represented, i.e. the combination of a value domain,
25 data type, and, if necessary, a unit of measure or a character set.
- 26 **Retired Common Schema** – The Common Schema which has become inactive meaning that new
27 joined-up projects are no longer recommended to use it.
- 28 **Supplementary Component** – A Supplementary Component gives additional meaning to the Content
29 Component in the Core Component Type. Supplementary Components shall be stored as part of the
30 Core Component Type to which they belong.
- 31 **UID** – Unique identifier of a dictionary entry in the data dictionary.
- 32 **Universal Business Language (UBL)** – UBL envisions a world where all companies, large and small,
33 can interact seamlessly with their trading partners as if they were part of the same virtual enterprise. It
34 achieves that goal by standardizing the form of information exchange.
- 35 **UN/CEFACT Modelling Methodology (UMM)** – It uses UML as the modelling technique to
36 specify business requirements and data so that they can be shared internally and provided
37 externally in a consistent manner.

- 1 **Unified Modelling Language (UML)** – A standard notation for the modelling of real-world objects as
- 2 a first step in developing an object-oriented design methodology.

- 3 **XML** – Please refer to Extensible Markup Language.

- 4 **XML Schema**- An XML Schema expresses shared vocabularies and allows machines to carry out
- 5 rules made by people. It provides a means for defining the structure, and content of an XML document.

- 6 **XML Schema Definition (XSD)** – XSD specifies how to formally describe the elements in an
- 7 Extensible Markup Language (XML) document. This description can be used to verify that each item
- 8 of content in a document adheres to the description of the element in which the content is to be placed.

- 9 **XMLCG** – XML Coordination Group supervises the Common Schema Management Process and
- 10 directs the policy enforcement. It also makes approval decision to all requests related to Common
- 11 Schemas and the management process.